

NEW!

The sliding door solution for all ceiling-mounted multi-track installations from 50kg up to 150kg!



TELESCOPIC USE



SOFT CATCH



CEILING MASTER



COMFORT STOP



PERFECT CLOSE

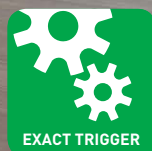

EXACT TRIGGER

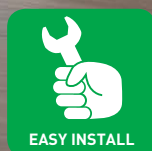

EASY INSTALL



TELESCOPIC USE

The telescopic solution for a wider clearance width



Portavant 150 multiline is the ideal solution for all ceiling-mounted applications requiring a large passageway whilst minimising the space used by the sliding sashes when open.

While with a single-track sliding door the passageway cannot be wider than either the sidelight or the wall space at the side accommodating the sliding sash when it is open, thanks to its telescopic function, Portavant 150 multiline enables much wider passageways: up to five sliding sashes can be stacked parallel to each other.

Floating floor guides keep the entire passageway free of trip hazards.

This is why Portavant 150 multiline with its telescopic function is a great solution for partition walls or for separating small spaces such as kitchens, corridors, bathrooms etc.

TELESCOPIC USE ensures that the sliding sashes require very little space when open.

Examples of installation situations:

Separating a small room:
one-sided system with 3
sliding sashes

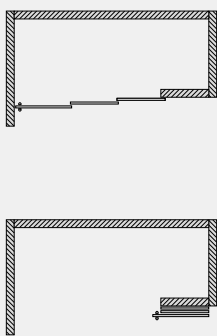

Partition wall: one-sided
system with 5 sliding sashes

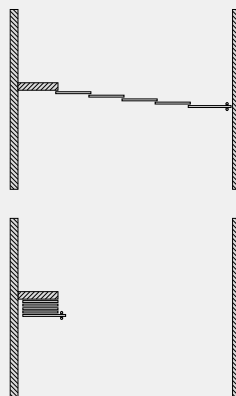

Partition wall: two-sided
system with 1 sidelight and 2
sliding sashes at each side

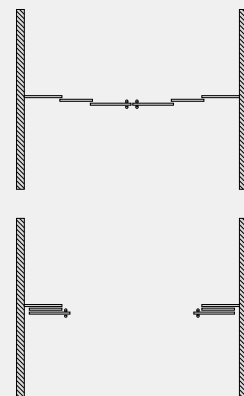

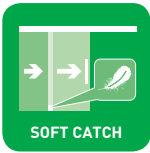

SOFT CATCH

The cushioning solution for gentle multiple-sash sliding



Portavant 150 multiline can be opened with a flick of a wrist. The soft catch function ensures that each sash triggers the sliding movement of the following sash. Thanks to integrated dampers, the sashes follow quietly and gently.

While you slide the first sash, SOFT CATCH makes sure that all the others follow quietly and gently.



CEILING MASTER

The perfect solution for all ceiling-mounted installations

Portavant 150 multiline is the perfect solution for all ceiling-mounted installations. As all components are inserted into the track profile laterally, the glass panel fitted with clamping jaws is mounted into the twin roller assembly from below and all settings, such as height and end positions, are also adjusted from below. Portavant 150 multiline can also be easily installed in a ceiling pocket, in front of a lintel or in suspended ceilings. Of course, all systems can also be installed with sidelights.

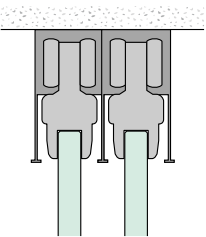
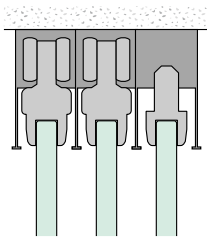
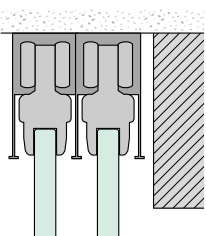
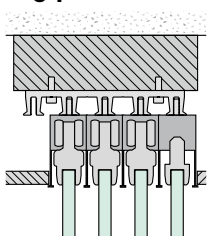
<p>Standard ceiling mounting</p> 	<p>Ceiling mounting with sidelight</p> 
<p>Installation in front of a lintel</p> 	<p>Installation in a suspended ceiling with Vitris ceiling joining profile</p> 

Thanks to CEILING MASTER, Portavant 150 multiline is a real all-rounder when it comes to ceiling mounting.



COMFORT STOP

The cushioning system for your safety

Before the end positions are reached, an innovative cushioning system slows down all sashes gently and quietly over a distance of several centimetres.

COMFORT STOP

- prevents the door from banging hard, thus avoiding the associated noise and vibrations.
- reliably protects against glass breakage and damage to fittings and walls.
- prevents damage through doors derailing or tilting.
- removes the risk of trapped fingers almost entirely.

COMFORT STOP ensures that everything you appreciate remains safe.



PERFECT CLOSE

The retraction system for perfectly closed doors

The PERFECT CLOSE retraction system closes the sashes fully and safely once they have been slowed down by the innovative cushioning system and

- ensures that the door closes completely even if not fully shut when in a hurry.
- keeps the door in position and prevents it from bouncing back.
- averts undesirable consequences, such as draughts, energy wastage and lack of noise protection, as well as visual impairment of a space because doors are not fully closed.

The spring force to close the doors can be adjusted in two levels (level 1: 50kg to 100kg and level 2: 100kg to 150kg) to the weight of the door, so enabling the smallest possible opening resistances.

PERFECT CLOSE ensures silence, discretion and wellbeing in gently closed spaces.

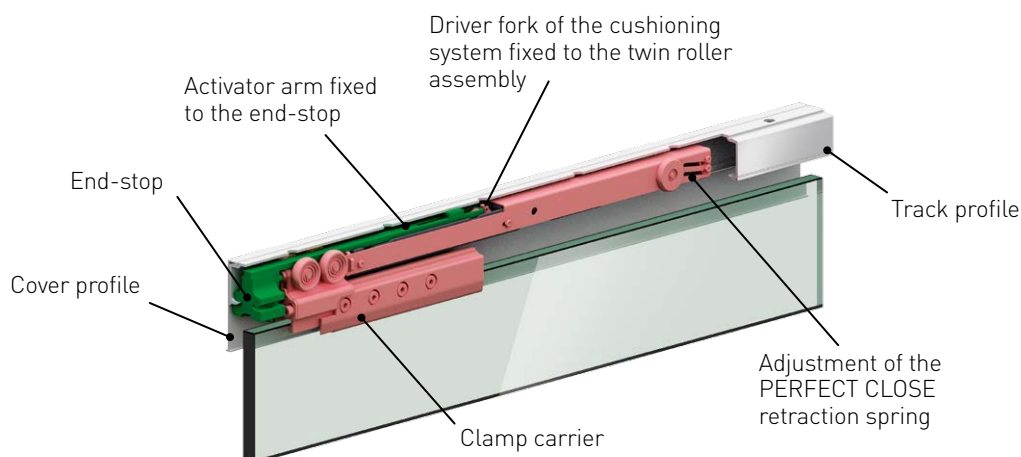



EXACT TRIGGER

The mechanism ensuring a reliable function

Inside Portavant 150 multiline, the proven design principle of the Portavant series ensures outstanding quality and technology:

Faultless assembly

As the activators are connected to the end-stops, they are always in the correct position, thus ensuring reliable activation of the cushioning systems attached to the twin roller assemblies on a permanent basis. This prevents damage to the cushioning systems in the event of faulty adjustment.

Excess load protection

If the door is closed too hard, it still has some momentum at the end of the cushioning process. If this happens with Portavant 150 multiline, the end-stop stops the door and prevents components of the cushioning system from breaking.

Tolerance when installation is not in an exactly vertical alignment

The cushioning system is fully functional even when the track profile has not been installed exactly perpendicular to the glass door. The cushioning system and the activator are both perfectly aligned due to the geometry of the track profile. The swivelling clamp fixture compensates for any deviations from perpendicular alignment. Tolerances of +/- 2.5mm are permissible.

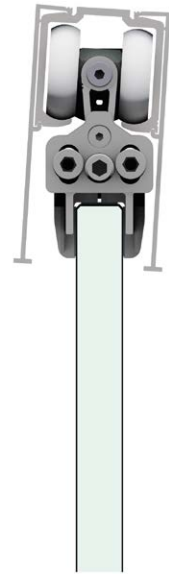

With EXACT TRIGGER, the cushioning mechanism will always work correctly.



EASY INSTALL

The clever solution for maximum installation comfort

Portavant 150 multiline offers the greatest ease of assembly in all ceiling-mounted applications. Installation takes just a few steps.

First, the drill holes are made for the track profiles. A ceiling joining profile is optionally available for multi-track systems in suspended ceilings. The cover profiles are then clipped onto the track profiles and the twin roller assemblies with the cushioning unit, as well as the end-stops with the activators, are inserted laterally into the track profiles. Then the track profiles – pre-assembled in this way – are installed. After assembling the mounting plate for the fixed floor guide, the sashes with the mounted glass clamps are inserted from below into the track profile and the twin roller assemblies are connected with the glass clamp holders. Finally, the fixed and the floating floor guides and catches are mounted and the end positions and the height of the sliding sashes are adjusted. Each sash can be adjusted in height by $\pm 2.5\text{mm}$.

EASY INSTALL makes the installation of glass sliding doors a breeze.

Familiar Willach quality

For more than 125 years, Willach has stood for the highest quality, excellent workmanship and products with a long service life. Every product in the Portavant 150 range offers Willach's familiar high quality:

The highest technical quality

- Minimum initial rolling resistance (Grade 3, EN 1527) results in outstanding easy running characteristics
- Extremely long service life (100,000 cycles, EN 1527)
- Corrosion resistance (suitable for humid interior spaces in accordance with EN 1527/1670)
- No maintenance

Traditional delivery reliability

The standard product range is held in stock at Ruppichteroth (Germany) and delivered with Willach's familiar delivery reliability and dependability.

Competent advice

Our technical office and field staff offer competent advice and technical support for all your questions. With Portavant 150 multiline, you benefit from the company's traditionally high service quality.



Technical information

Weight of sliding sashes	From 50kg to 150kg per sliding sash with cushioning on both sides
Glass width of sliding sashes	≥ 960mm The maximum height-width ratio of the sliding sashes is 3:1.
Dimensions of the overall system	Max. 6000mm with one-sided systems and max. 12000mm with two-sided systems; max. 5 track profiles/sidelight support profiles next to each other
Glass thickness of sliding sashes and sidelight	
Tempered glass	10mm / 12mm
Laminated safety glass (made of tempered glass)	10.76mm / 12.76mm
Available profile lengths	1996mm, 2996mm, 3996mm, 5996mm as well as fixed lengths
Twin roller assemblies	High-quality, precise roller bearings with plastic coating
Execution	Always cushioned on both sides; multi-track systems with each sash triggering the sliding movement of the following sash; ceiling mounting: one or two-sided; closing to the left or right; also with sidelight(s); colour EV1 (matt aluminium)

Broad model range to meet customer requirements

Ceiling mounting

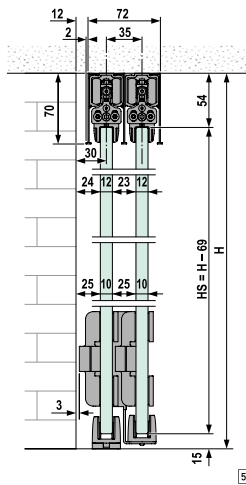

579.EV187M.1604

Ceiling mounting with sidelight

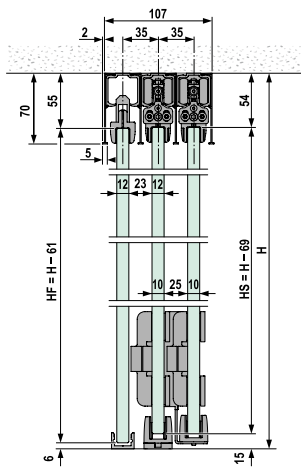

580.EV187M.1604

Please note that glass drill holes are required. You can download the corresponding drawings from www.willach.com.

Here you will also find planning advice for fixing the profiles to the ceiling.

One-sided systems without sidelight

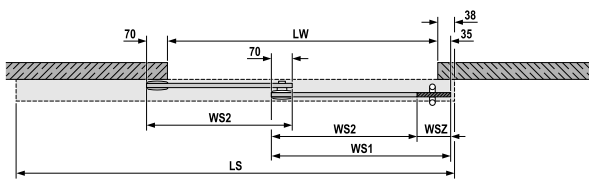

$$WS2 = \frac{LW - WSZ + 70n + 35}{n} \quad WS1 = WS2 + WSZ \quad LS = LW + WS2 + 48 \quad LWt = LW - WSZ$$

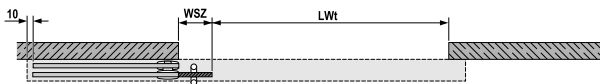

Closing to the left or right

581.EV187M.1604

Two-sided systems without sidelight

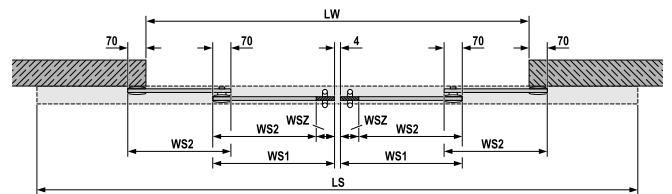

$$WS2 = \frac{LW - 2WSZ + 70n - 4}{n} \quad WS1 = WS2 + WSZ \quad LS = LW + 2WS2 + 20 \quad LWt = LW - 2WSZ$$

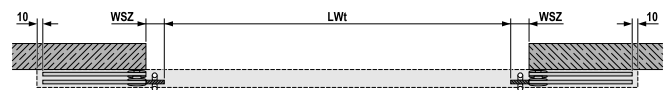

582.EV187M.1604

One-sided systems with sidelight

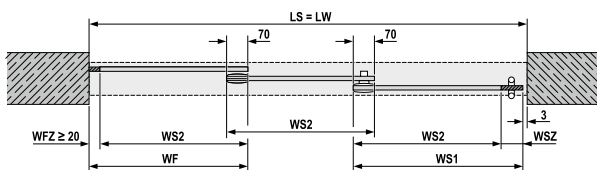

$$WS2 = \frac{LW - WSZ - WFZ + 70n - 3}{n + 1} \quad WS1 = WS2 + WSZ \quad WF = WS2 + WFZ$$

$$LS = LW \quad LWt = LW - WSZ - WF$$

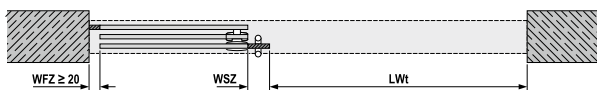

Closing to the left or right

Two-sided systems with sidelights

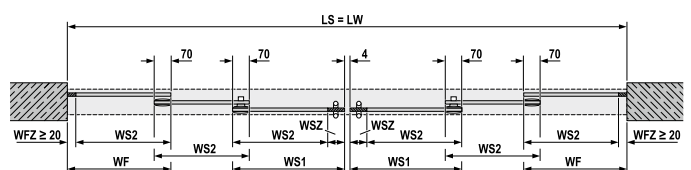

$$WS2 = \frac{LW - 2WSZ - 2WFZ + 70n - 4}{n + 2} \quad WS1 = WS2 + WSZ \quad WF = WS2 + WFZ$$

$$LS = LW \quad LWt = LW - 2WSZ - 2WFZ$$

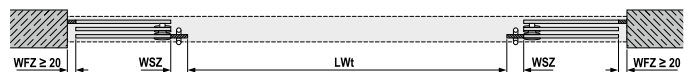

Legend

H	= System height
HF	= Glass height of sidelight
HS	= Glass height of sliding sash
LS	= Length of track profile/sidelight support profile
LW	= Clear width (building)
LWt	= Clear width of wall opening (passage width)

n	= Number of sliding sashes
WF	= Glass width of sidelight
WFZ	= Additional width of sidelight
WS1	= Glass width of sliding sash 1 with handle
WS2	= Glass width of sliding sash 2
WSZ	= Additional width of sliding sash for handle



The company

With its VITRIS product division, Willach is among the leading producers of glass fittings in Europe. Since its foundation in 1889, the company has been dedicated to the manufacture of products to the highest quality and precision standards. Willach quickly cemented its pioneering reputation with numerous technical innovations and intelligent solutions that paid close attention to intricate detail. With the Portavant product line, Willach today offers a range of elegant, technically sophisticated fittings for interior glass sliding doors. The Aquant product line includes high-quality fittings for shower glass sliding doors. Furthermore, the VITRIS product range comprises a comprehensive modular system of showcase fittings, sliding door locks and slot bar systems for discerning interior, shop and trade show furnishings. VITRIS products are certified in accordance with ISO standards and are manufactured at our Ruppichteroth production site in Germany to stringent manufacturing standards. This forms the basis for the excellent quality and consistently high level of availability of the entire VITRIS range.

Please contact us and we will be happy to advise you!

Gebr. Willach GmbH Stein 2
53809 Ruppichteroth
Germany
Tel.: +49 (0)2295 92 08 -421/-427
Fax: +49 (0)2295 92 08 429
vitris@willach.com · www.willach.com

WillachGroup
since 1889



Stamp

Product descriptions, drawings and illustrations represent neither assured characteristics nor declaration of guarantee. Subject to change, errors excepted.

Edition 09/2016