

TECHNIK KATALOG // TECHNICAL CATALOGUE

GLASTÜR-SYSTEME //
GLASS DOOR SYSTEMS

Glas-Innentürbänder // interior glass door hinges

Halteklammern, Anschlagwinkel // connectors, door stoppers

Anschlagtürbänder eckig // single action door hinges square

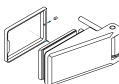
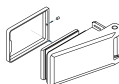
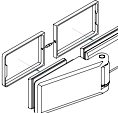
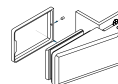
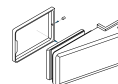
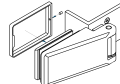
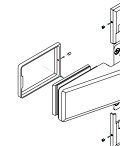
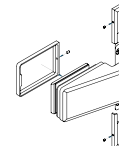
								
DIN rechts // right :	09510* 09512	09520* 09522	09530* 09532	09540* 09542	09550* 09552	09560* 09562	09570* 09572	09580* 09582
DIN links // left :	09511* 09513	09521* 09523	09531* 09533	09541* 09543	09551* 09553	09561* 09563	09571* 09573	09581* 09583





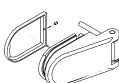
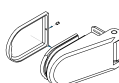
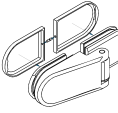
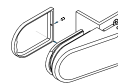
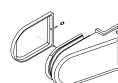
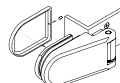
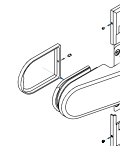
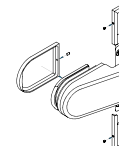













* mit Schließkraftverstellung //with closing force adjustment

Anschlagtürbänder rund // single action door hinges round

								
DIN rechts // right :	09610* 09612	09620* 09622	09630* 09632	09640* 09642	09650* 09652	09660* 09662	09670* 09672	09680* 09682
DIN links // left :	09611* 09613	09621* 09623	09631* 09633	09641* 09643	09651* 09653	09661* 09663	09671* 09673	09681* 09683



* mit Schließkraftverstellung //with closing force adjustment

Halteklammern, Anschlagwinkel // connectors, door stoppers

					
09160	09162	09164	09260	09262	09264
					
09165	09166	09167	09168	09169	
					
09265	09266	09267	09268	09269	09301
					
					09302

AUF EINEN BLICK // AT A GLANCE

Spezielle Informationen zu Chalet® AT (Glastür-System)
 Special informations on Chalet® AT (glass door system)

Chalet® AT	Art.Nr. art.no.				Basismaterial base material	max. Tragf. je Bandpaar max. carrying cap. per hinge pair		ESG ⁵⁾ -Stärke tempered glass ⁵⁾ thickness		
	DIN* rechts right	DIN* links left	DIN rechts right	DIN links left		Messing // brass	 in mm	 in kg	8 mm	8,76 mm ⁶⁾
Glas-Innentürbänder eckig // interior glass door hinges	09510	09511	09512	09513	●	1000 x 2100	45	●	●	○
	09520	09521	09522	09523	●	1000 x 2100	45	●	●	○
	09530	09531	09532	09533	●	1000 x 2100	45	●	●	○
	09540	09541	09542	09543	●	1000 x 2100	45	●	●	○
	09550	09551	09552	09553	●	1000 x 2100	45	●	●	○
	09560	09561	09562	09563	●	1000 x 2100	45	●	●	○
	09570	09571	09572	09573	●	1000 x 2100	45	●	●	○
	09580	09581	09582	09583	●	1000 x 2100	45	●	●	○
Glas-Innentürbänder rund // interior glass door hinges round	09610	09611	09612	09613	●	1000 x 2100	45	●	●	○
	09620	09621	09622	09623	●	1000 x 2100	45	●	●	○
	09630	09631	09632	09633	●	1000 x 2100	45	●	●	○
	09640	09641	09642	09643	●	1000 x 2100	45	●	●	○
	09650	09651	09652	09653	●	1000 x 2100	45	●	●	○
	09660	09661	09662	09663	●	1000 x 2100	45	●	●	○
	09670	09671	09672	09673	●	1000 x 2100	45	●	●	○
	09680	09681	09682	09683	●	1000 x 2100	45	●	●	○

Lieferung // Delivery

- standardmäßig lieferbar // *standard available*
- ⊗ für Lieferung sind Angaben des Kunden erforderlich // *details by the client are necessary for delivery*
- für Lieferung ist Rücksprache erforderlich // *consultation is necessary for delivery*

Lieferbare Oberflächen gemäß aktueller Preisliste //
 Available surfaces according to current pricelist

Hinweis:

- * unteres Türband mit Schließkraftverstellung
- ⁵⁾ Bitte beachten Sie die Eigenschaften und die statische Belastbarkeit von ESG. Nach DIN EN 12150-1:2000.
- ⁶⁾ VSG 8,76 mm aus 2x4 mm ESG + 0,76 mm PVB Folie

Information:

- * lower hinge with closing force adjustment
- ⁵⁾ Please take note on the properties and static load capacity of LSG. According to European Norm (DIN EN 12150-1:2000).
- ⁶⁾ Laminated safety glass consisting of 2x4 mm safety glass + 0,76 mm PVB foil

AUF EINEN BLICK // AT A GLANCE

Spezielle Informationen zu Chalet® AT (Glastür-System)
Special informations on Chalet® AT (glass door system)

Chalet® AT	Art.Nr. art.no.		Basismaterial base material	ESG ⁵⁾ -Stärke tempered glass ⁵⁾ thickness		
	eckig // square	rund // round		Messing // brass	8 mm	8,76 mm ⁶⁾
Halteklammern // connectors	09160	09260	●	●	○	○
	09162	09262	●	●	○	○
	09164	09264	●	●	○	○
	09165	09265	●	●	○	○
	09166	09266	●	●	○	○
	09167	09267	●	●	○	○
	09168	09268	●	●	○	○
	09169	09269	●	●	○	○

Chalet® AT	Art.Nr. art.no.	Basismaterial base material
		Messing // brass
Anschlagwinkel // door stoppers	09301	●
	09302	●

Lieferung // Delivery

- standardmäßig lieferbar // *standard available*
- ⊗ für Lieferung sind Angaben des Kunden erforderlich // *details by the client are necessary for delivery*
- für Lieferung ist Rücksprache erforderlich // *consultation is necessary for delivery*

Lieferbare Oberflächen gemäß aktueller Preisliste //
Available surfaces according to current pricelist

Hinweis:

- * unteres Türband mit Schließkraftverstellung
- ⁵⁾ Bitte beachten Sie die Eigenschaften und die statische Belastbarkeit von ESG. Nach DIN EN 12150-1:2000.
- ⁶⁾ VSG 8,76 mm aus 2x4 mm ESG + 0,76 mm PVB Folie

Information:

- * lower hinge with closing force adjustment
- ⁵⁾ Please take note on the properties and static load capacity of LSG. According to European Norm (DIN EN 12150-1:2000).
- ⁶⁾ Laminated safety glass consisting of 2x4 mm safety glass + 0,76 mm PVB foil

Chalet® AT: Montage und Pflege

Beispiele

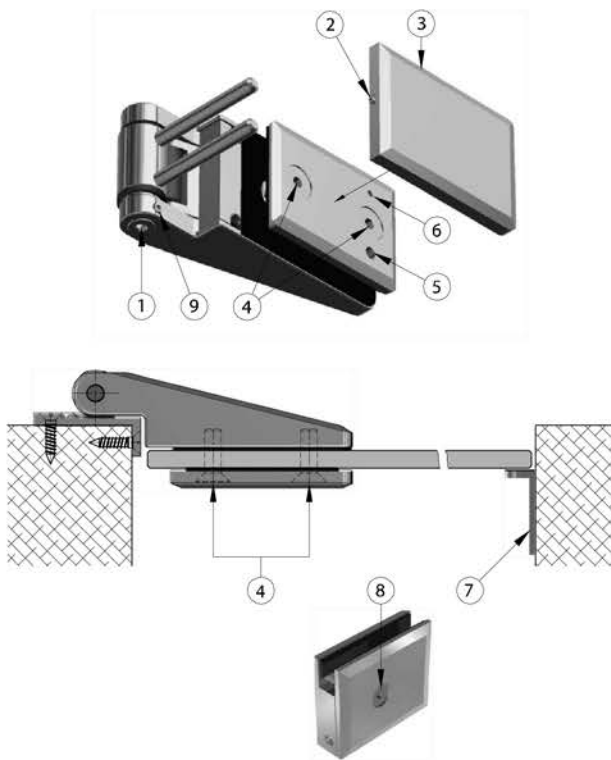

Chalet® AT Anschlagtürsystem

Chalet® AT ist ein hochwertiges Anschlagtürsystem mit selbstschließender Funktion für die Anwendung im Innenbereich. Chalet® AT Drehtürbänder ermöglichen das Öffnen der Tür in eine Richtung. Als Handhabe der Tür sind ausschließlich Griffstangen oder Griffknöpfe zu verwenden. Der Einbau kann sowohl in verschiedenen Normzargen, aber auch ohne Rahmen erfolgen.

Glasart / Glasdicke / Glasbearbeitung

Die Beschläge sind für 8 mm Einscheibensicherheitsglas bzw. 8,76 mm Verbundsicherheitsglas aus 2x 4mm ESG + 0,76 mm PVB-Folie vorgerichtet.

Es ist ESG nach DIN EN 12150-1:2000 zu verarbeiten. Freistehende Glaskanten und Glasecken an den Glasscheiben müssen so gefast und geschliffen sein, dass beim Benutzen und beim Reinigen keine Verletzungsgefahr besteht. Standardabweichende Glaspositionierung erfordert ggf. eine angepasste Glasbearbeitung.

Größe und Gewichte pro Drehtürbandpaar

max. Türflügelgewicht:	45 kg
max. Türbreite:	1000 mm
max. Türhöhe:	ca. 2100 mm

Hinweis Glasbohrungen / Glasausschnitte

Gläser im Bereich der Band- / Verbinderverschraubungen reinigen.

In die Glasbohrungen und Glasausschnitte für die Band- / Verbinder- / Griffverschraubungen unbedingt die mitgelieferten Kunststoffschlauchabschnitte bzw. Kunststoffstreifen als Schutz zwischen Glas und Beschlag (Schraube) einsetzen.

Montage der Drehtürbänder und Verbinder

Zunächst Klemmschrauben [2] (Inbus SW 1,5) lösen und Abdeckungen [3] entfernen.

Bitte stellen Sie sicher, dass die Drehtürbänder die, für die Bausituation, richtige DIN Richtung aufweisen.

Die DIN-Richtung des unteren Drehtürbandes mit der eingebauten Bremse, erkennt man an der Lage der Stellschraube [1] (nach unten zeigend). Außerdem muss bei beiden Bändern die größere Bohrung [5] ($\varnothing 6$ mm) nach unten zeigen. Die Drehtürbänder waagrecht, sowie die Achsen des übereinander stehenden Bandpaares im Lot montieren!

Türflügel fachgerecht ausrichten und die Klemmplatte mit den Befestigungsschrauben [4] (Inbus SW 5) fest verschrauben.

Als zusätzliche Sicherungsmaßnahme, beim Einsatz von VSG, besteht die Möglichkeit die Glasbohrungen mit Injektionsmörtel auszufüllen. Wichtig ist, dass vor dieser Maßnahme die Funktion des Chalet® AT Anschlagtürsystems sichergestellt worden ist.

In die untere Bohrung [5] ($\varnothing 6$ mm) der Klemmplatte wird der Injektionsmörtel (Hilti Hit) so lange eingespritzt bis die Masse an der Enlüftungsbohrung [6] ($\varnothing 3$ mm) wieder austritt. Die entsprechenden Kunststoffschlauchabschnitte bzw. Kunststoffstreifen kommen hierbei nicht zum Einsatz.

Nach der erfolgten Montage und nochmaligem Nachziehen der Verschraubungen werden die Abdeckungen [3] wieder aufgeschoben und mit den Klemmschrauben [2] geklemmt. Bei Montage ohne Falzanschlag ist eine Fehlbedienung der Tür (Öffnung entgegen der Öffnungsrichtung) durch einen Anschlag [7] zu verhindern.

Halteklammern fachgerecht montieren. Die Klemmplatten der Halteklammern werden mit Schraube [8] (Inbus SW 4) verschraubt.

Einstellbare Schließgeschwindigkeit der Drehtürbänder

Tür nach der Montage öffnen und Schließgeschwindigkeit überprüfen. Tür steht bei ca. 90° Öffnungswinkel. Ab ca. 80° beginnt der automatische Schließvorgang.

Mit der Stellschraube [1] (Inbus SW 4) die eingebaute Bremse so arretieren, dass die Schließgeschwindigkeit der Türgröße entsprechend angepasst ist.

Zum Schluss mit der Sicherungsschraube [9] (Inbus SW 2,5) die Stellschraube [1] sichern.

Befestigungsmaterialien

Die statisch notwendigen Befestigungsmaterialien, für die Montage der Drehtürbänder und Verbinder an den tragenden Baukörper, müssen vom Verarbeiter bestimmt werden.

Montage

Die Montage sollte nur von einem Fachmann durchgeführt werden.

Pflegehinweis

Das Chalet® AT Anschlagtürsystem darf nur mit warmem Wasser und einem weichen Tuch (Microfaser) feucht abgewischt und gegebenenfalls nachgetrocknet werden. Scharfe, aggressive sowie z.B. alkalische oder chlorhaltige Reiniger, Scheuermittel (z.B. Stahlwolle) bzw. Lösungsmittel dürfen nicht verwendet werden.

Chalet® AT: mounting and care

Examples

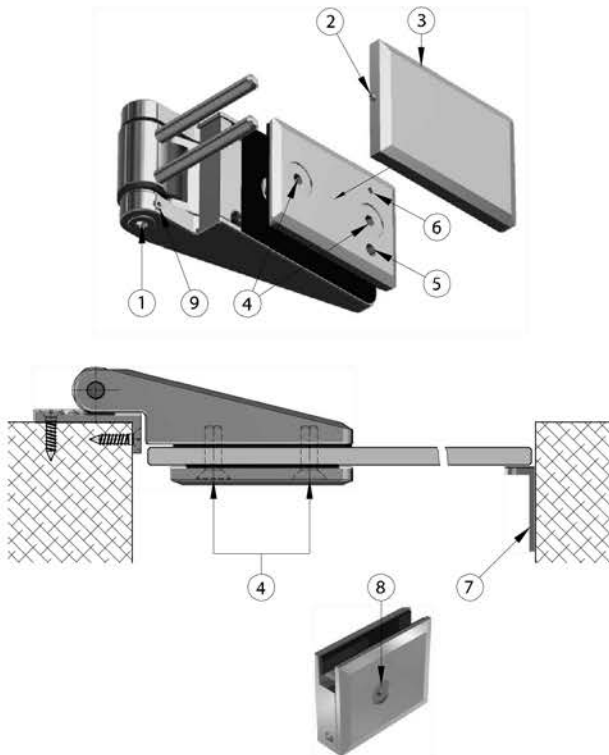

Chalet® AT single action door system

Chalet® AT is a high quality single action door system with automatic closing function for use indoors. Chalet® AT revolving door hinges make it possible to open the door in one direction. Only door bars or door knobs are to be used as handles for the door. Assembly can be in various standard frames as well as without a frame.

Glass type / glass thickness / glass conditioning

The fittings are intended for 8 mm tempered safety glass and/or 8,76 mm laminated safety glass made by 2 x 4 mm tempered glass + 076 mm PBV-sheet. Tempered safety glass must be used in accordance with the DIN EN 12150-1:2000. Freestanding glass edges and glass corners on the sheets of glass must be bevelled and cut in such a way that no form of injury will result upon use or cleaning. Positioning of the glass in another than standard manner requires corresponding and appropriate glass conditioning.

Size and weight per revolving door hinge pair

maximum door leaf weight:	45 kg
maximum door width:	1000 mm
maximum door height:	app. 2100 mm

Advice for glass bores/ glass cutouts

Clean the glass in the vicinity of the hinge/ joint screw connections. In the glass bores and glass cutouts for the hinge/ joint/ handle screw connections, be sure to use the portions of plastic tubing or the plastic strips included with the delivery as protection between the glass and the fitting (screw).

Mounting of the revolving door hinges and joints

First solve clamping screw [2] (Allan key, size 1,5) and then remove cover [3].

Please ensure that the revolving door hinges possess the correct DIN direction for the building situation

The DIN direction of the bottom revolving door hinge with the built-in brake can be identified by the position of the adjusting screw [1] (pointing down). In addition the large hole [5] (ø6 mm) of both hinges must pointing downwards. Mount the revolving door hinges horizontally and the axes of the hinge pair as placed one on top of the other perpendicularly!

Align the door leaf and affix the fitting caps with the fastening screws [4] (Allan key, size 5).

As additional safeguard, with the application of laminated safety glass, there is an opportunity to fill out the glass bores with grouting mortar.

It is important, that before this measure, the function of the Chalet® AT single action door system was guaranteed. Inject the grouting mortar (Hilti Hit) into the lower hole [5] (ø6 mm) of the counter plate as long as the mass in the vent hole [6] (ø3 mm) withdraws.

The appropriate plastic tubes and/or the plastic strips are not used here.

After the mounting and subsequent tightening of the screw connections install the cover [3] and clamp it with the clamping screw [2]

In case of mounting without a groove, a malfunction of the door (opening in the wrong direction) can be prevented through use of a stopper [7].

Mount the clamps professionally. The clamping plates of the clamps are to be fastened with [8] screw (Allan key, size 4).

Adjustable closing speed of the revolving door hinges

After mounting, open the door and inspect the closing speed. The open angle of the door is approximately 90°. The automatic closure begins from approximately 80°.

Adjust the builtin brake with the adjusting screw [1] (Allan key, size 4) so that the closing speed corresponds appropriately to the size of the door.

Finally, secure the adjusting screw [1] with the safety screw [9] (Allan key, size 2,5).

Mounting materials

The statically necessary mounting materials for the mounting of the revolving door hinges and the angle joints onto the loadbearing structure must be determined by the persons responsible for the mounting.

Mounting

The mounting should only be carried out by an expert.

Care advice

Chalet® AT single action door system should only be cleaned with warm water and a damp, soft cloth (microfibre) and, if necessary, dried.

Caustic or aggressive cleaners, for example alkaline cleaners or cleaners containing chlorine, should not be used. Abrasives, such as steel wool, or solvents should also not be used.

Chalet® AT

Art.Nr. // art.no. 09510*, 09610*, 09512, 09612

Anschlagtürband Glas-Holzzarge DIN rechts // interior glass hinge glass-wooden frame right

09510*
09512

09610*
09612

Besonderheiten // Features

* unteres Türband mit Schließkraftverstellung // lower hinge with closing force adjustment

Alle Angaben in mm // all details in mm

Art.Nr. // art.no. 09511*, 09611*, 09513, 09613

Anschlagtürband Glas-Holzzarge DIN links // interior glass hinge glass-wooden frame left

09511*
09513

09611*
09613

Besonderheiten // Features

* unteres Türband mit Schließkraftverstellung // lower hinge with closing force adjustment

Alle Angaben in mm // all details in mm

Chalet® AT

Art.Nr. // art.no. 09520*, 09620*, 09522, 09622

Anschlagtürband Glas-Stahlzarge DIN rechts // interior glass hinge glass-steel frame right

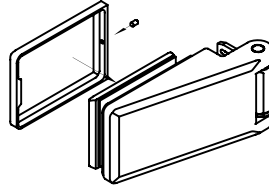
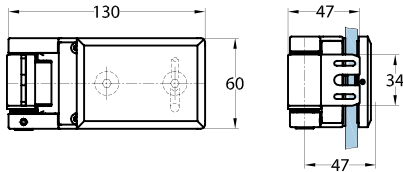

09520*
09522

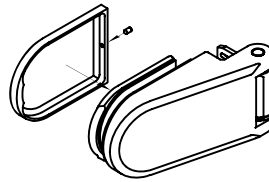
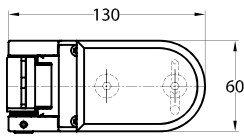

09620*
09622

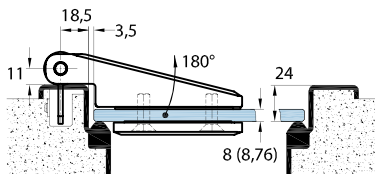

Glasbearbeitung // glass machining

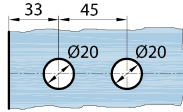

Besonderheiten // Features



* unteres Türband mit Schließkraftverstellung // lower hinge with closing force adjustment

Alle Angaben in mm // all details in mm

Art.Nr. // art.no. 09521*, 09621*, 09523, 09623

Anschlagtürband Glas-Stahlzarge DIN links // interior glass hinge glass-steel frame left

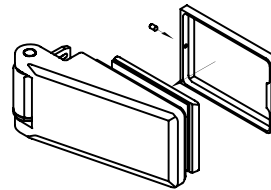
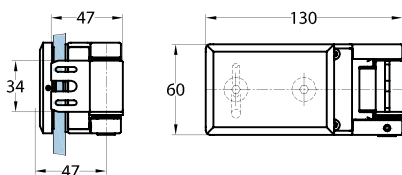

09521*
09523

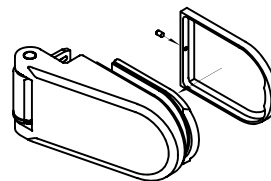
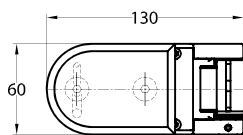

09621*
09623

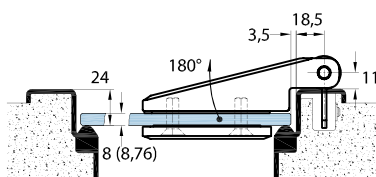

Glasbearbeitung // glass machining

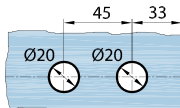

Besonderheiten // Features



* unteres Türband mit Schließkraftverstellung // lower hinge with closing force adjustment

Alle Angaben in mm // all details in mm

Chalet® AT

Art.Nr. // art.no. 09530*, 09630*, 09532, 09632

Anschlagtürband Glas-Glas 180° DIN rechts // *single-action door hinge glass-glass 180° right*

Art.-Nr. // art. nr.
09301
09302

Glasbearbeitung // glass machining

Besonderheiten // Features

VSG laminated glass

patent

MESSING BRASS

* unteres Türband mit Schließkraftverstellung // lower hinge with closing force adjustment

Alle Angaben in mm // all details in mm

Art.Nr. // art.no. 09531*, 09631*, 09533, 09633

Anschlagtürband Glas-Glas 180° DIN links // *single-action door hinge glass-glass 180° left*

Art.-Nr. // art. nr.
09301
09302

Glasbearbeitung // glass machining

Besonderheiten // Features

VSG laminated glass

patent

MESSING BRASS

* unteres Türband mit Schließkraftverstellung // lower hinge with closing force adjustment

Alle Angaben in mm // all details in mm

Chalet® AT

Art.Nr. // art.no. 09540*, 09640*, 09542, 09642

Anschlagtürband Glas-Holzzarge DIN rechts // single-action door hinge glass-wooden frame right

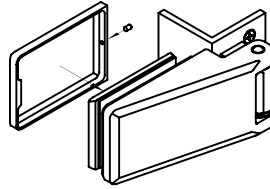
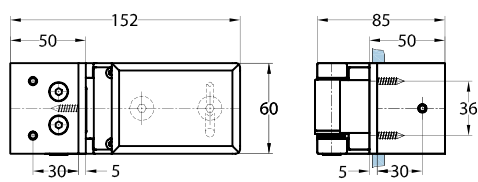

09540*
09542

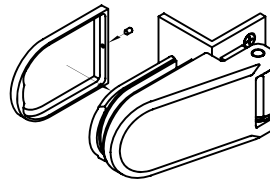
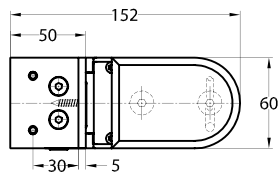

09640*
09642

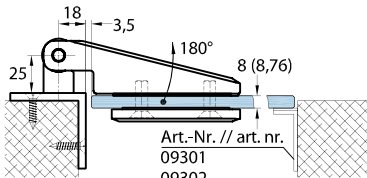

Art.-Nr. // art. nr.
09301
09302

Glasbearbeitung // glass machining

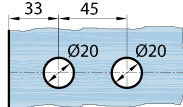

Besonderheiten // Features



* unteres Türband mit Schließkraftverstellung // lower hinge with closing force adjustment

Alle Angaben in mm // all details in mm

Art.Nr. // art.no. 09541*, 09641*, 09543, 09643

Anschlagtürband Glas-Holzzarge DIN links // single-action door hinge glass-wooden frame left

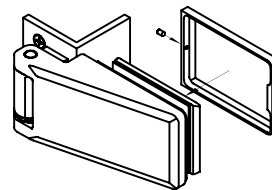
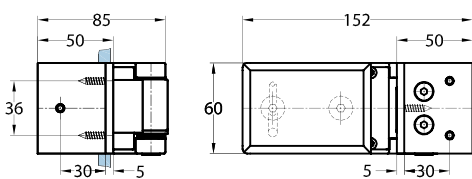

09541*
09543

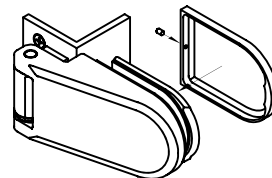
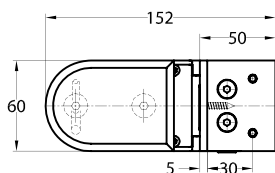

09641*
09643

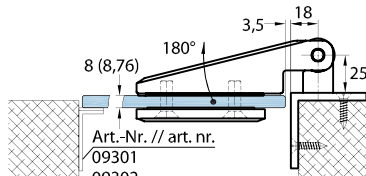

Art.-Nr. // art. nr.
09301
09302

Glasbearbeitung // glass machining

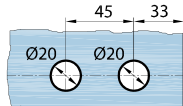

Besonderheiten // Features



* unteres Türband mit Schließkraftverstellung // lower hinge with closing force adjustment

Alle Angaben in mm // all details in mm

Chalet® AT

Art.Nr. // art.no. 09550*, 09650*, 09552, 09652

Anschlagtürband Glas-Holzzarge DIN rechts // single-action door hinge glass-wooden frame right

2 Montagemöglichkeiten // 2 facilities for mounting

I.
 15 21 3,5 180° 8 (8,76) 20
 Art.-Nr. // art. nr.
 09301
 09302
 Glasbearbeitung // glass machining
 33 45
 Ø20 Ø20

II.
 11 21 3,5 180° 8 (8,76) 24
 Art.-Nr. // art. nr.
 09301
 09302
 Glasbearbeitung // glass machining
 33 45
 Ø20 Ø20

Besonderheiten // Features

- VSG laminated glass
- patent
- MESSING BRASS

* unteres Türband mit Schließkraftverstellung // lower hinge with closing force adjustment

Alle Angaben in mm // all details in mm

Art.Nr. // art.no. 09551*, 09651*, 09553, 09653

Anschlagtürband Glas-Holzzarge DIN links // single-action door hinge glass-wooden frame left

2 Montagemöglichkeiten // 2 facilities for mounting

I.
 20 8 (8,76) 180° 3,5 21 15
 Art.-Nr. // art. nr.
 09301
 09302
 Glasbearbeitung // glass machining
 45 33
 Ø20 Ø20

II.
 24 8 (8,76) 180° 3,5 21 11
 Art.-Nr. // art. nr.
 09301
 09302
 Glasbearbeitung // glass machining
 45 33
 Ø20 Ø20

Besonderheiten // Features

- VSG laminated glass
- patent
- MESSING BRASS

* unteres Türband mit Schließkraftverstellung // lower hinge with closing force adjustment

Alle Angaben in mm // all details in mm

Chalet® AT

Art.Nr. // art.no. 09560*, 09660*, 09562, 09662

Anschlagtürband Glas-Mauerlaibung DIN rechts // single-action door hinge glass-jamb right

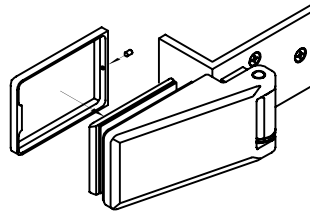
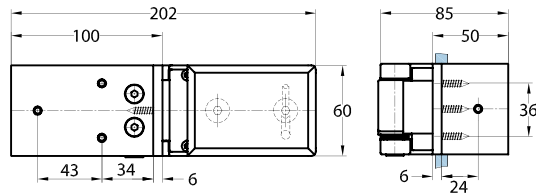

09560*
09562

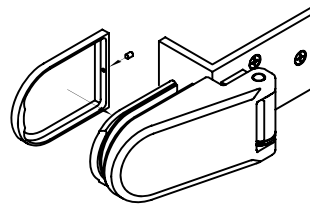
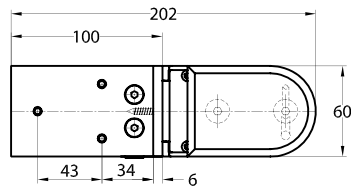

09660*
09662

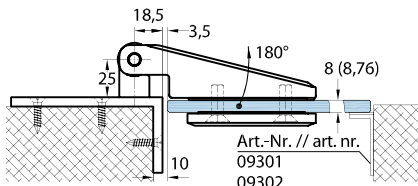

Glasbearbeitung // glass machining

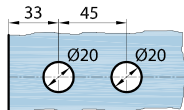

Besonderheiten // Features



* unteres Türband mit Schließkraftverstellung // lower hinge with closing force adjustment

Alle Angaben in mm // all details in mm

Art.Nr. // art.no. 09561*, 09661*, 09563, 09663

Anschlagtürband Glas-Mauerlaibung DIN links // single-action door hinge glass-jamb left

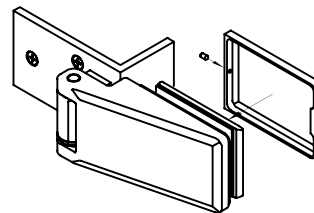
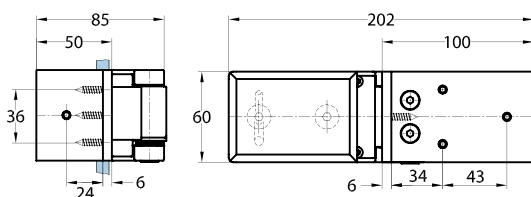

09561*
09563

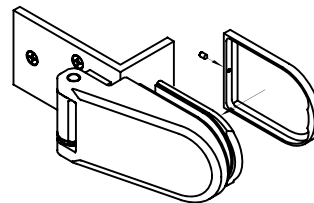
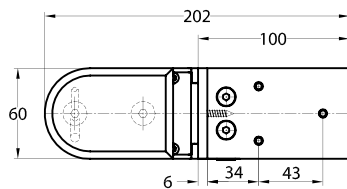

09661*
09663

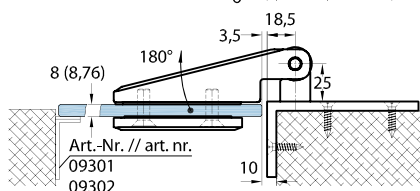

Glasbearbeitung // glass machining

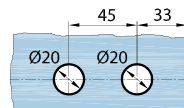

Besonderheiten // Features



* unteres Türband mit Schließkraftverstellung // lower hinge with closing force adjustment

Alle Angaben in mm // all details in mm

Chalet® AT

Art.Nr. // art.no. 09570*, 09670*, 09572, 09672

Anschlagtürband Glas-Holzzarge DIN rechts // single-action door hinge glass-wooden frame right

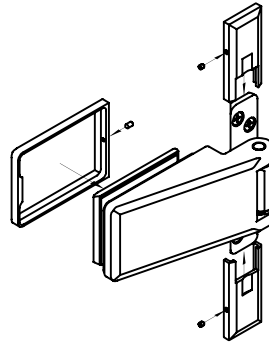
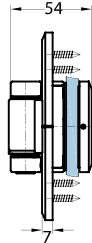
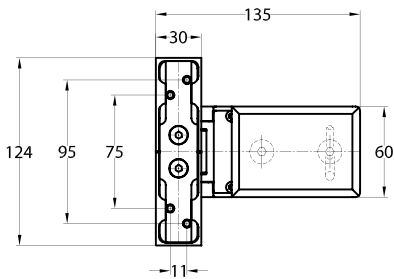

09570*
09572

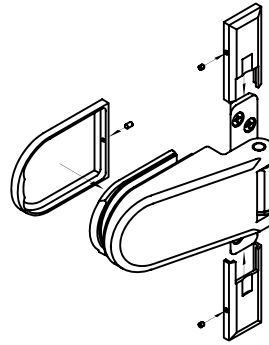
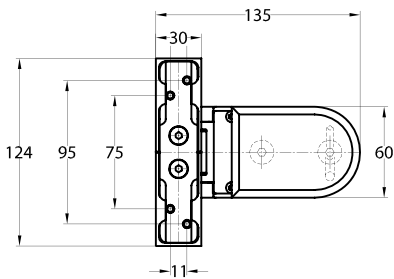

09670*
09672

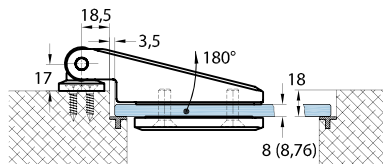

Glasbearbeitung // glass machining

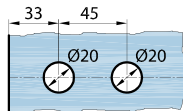

Besonderheiten // Features



* unteres Türband mit Schließkraftverstellung // lower hinge with closing force adjustment

Alle Angaben in mm // all details in mm

Chalet® AT

Art.Nr. // art.no. 09571*, 09671*, 09573, 09673

Anschlagtürband Glas-Holzzarge DIN links // single-action door hinge glass-wooden frame left

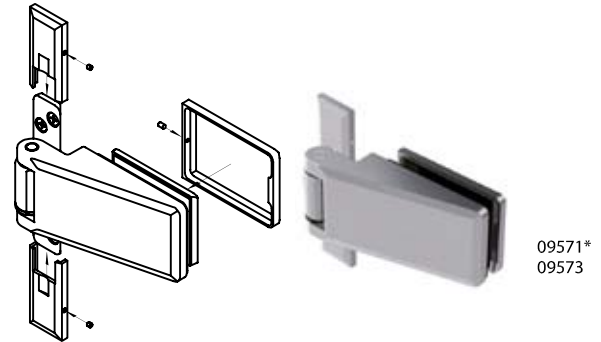
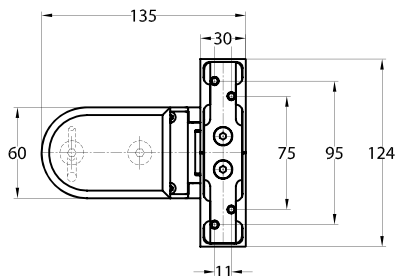
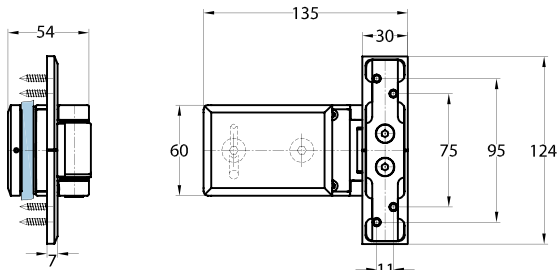

09571*
09573

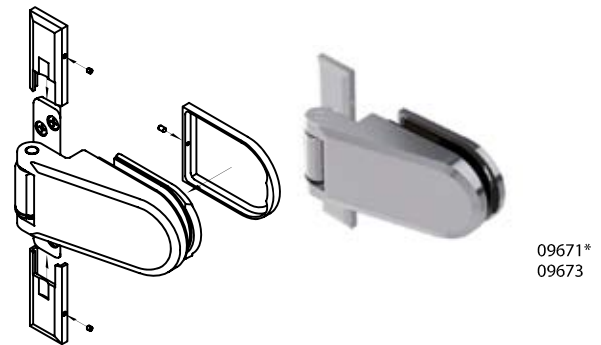

09671*
09673

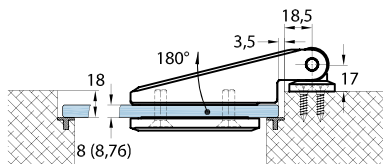

Glasbearbeitung // glass machining

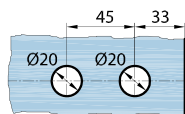

Besonderheiten // Features



* unteres Türband mit Schließkraftverstellung // lower hinge with closing force adjustment

Alle Angaben in mm // all details in mm

Chalet® AT

Art.Nr. // art.no. 09580*, 09680*, 09582, 09682

Anschlagtürband Glas-Holzzarge DIN rechts // single-action door hinge glass-wooden frame right

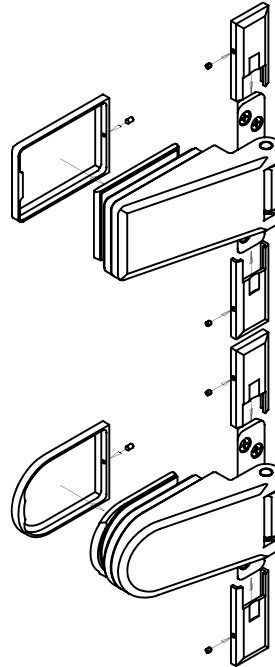
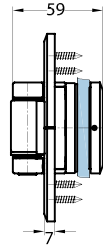
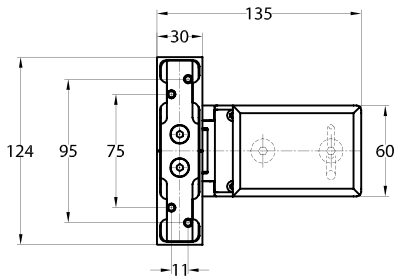

09580*
09582

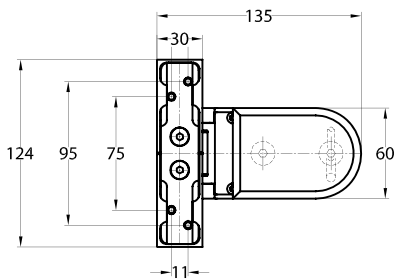

09680*
09682

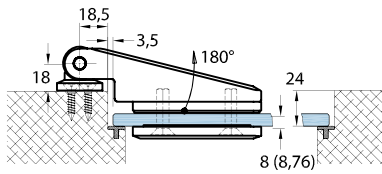

Glasbearbeitung // glass machining

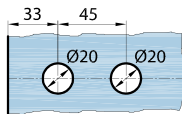

Besonderheiten // Features



* unteres Türband mit Schließkraftverstellung // lower hinge with closing force adjustment

Alle Angaben in mm // all details in mm

Chalet® AT

Art.Nr. // art.no. 09581*, 09681*, 09583, 09683

Anschlagtürband Glas-Holzzarge DIN links // single-action door hinge glass-wooden frame left

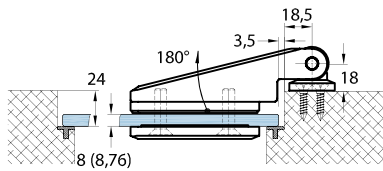
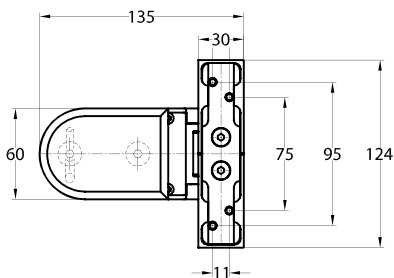
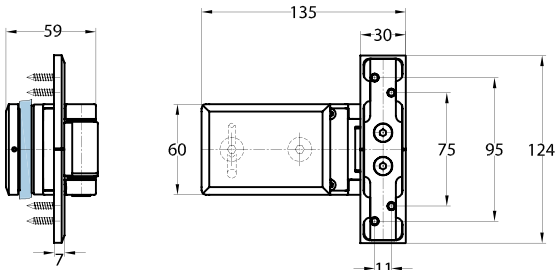

Glasbearbeitung // glass machining

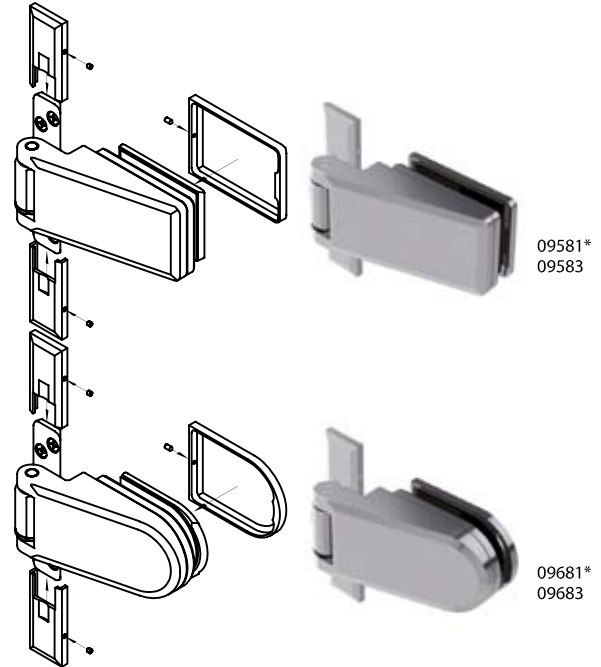
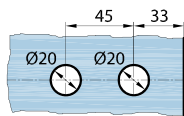

Besonderheiten // Features



* unteres Türband mit Schließkraftverstellung // lower hinge with closing force adjustment

Alle Angaben in mm // all details in mm

Chalet® AT

Art.Nr. // art.no. 09160, 09260

Halteklammer für Glas-Bodenbefestigung, links 90° ; oder Glas-Deckenbefestigung, rechts 90° //
 clamp for glass-floor mounting, left 90° ; or for glass-ceiling mounting, right 90°

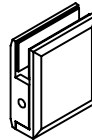
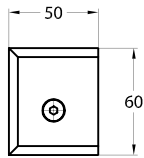
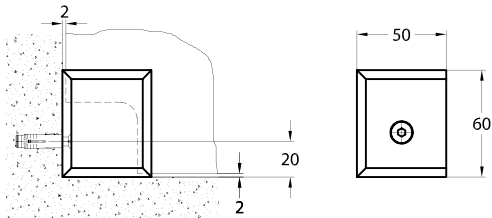

09160

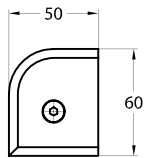
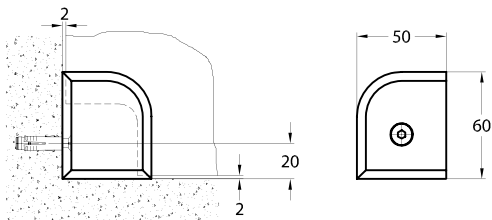

09260

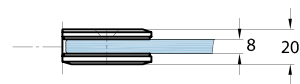

Glasbearbeitung // glass machining

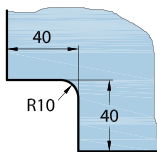

Besonderheiten // Features



Alle Angaben in mm // all details in mm

Art.Nr. // art.no. 09162, 09262

Halteklammer für Glas-Deckenbefestigung, links 90° ; oder Glas-Bodenbefestigung, rechts 90° //
 clamp for glass-ceiling mounting, left 90° ; or for glass-floor mounting, right 90°

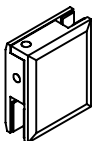
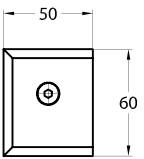
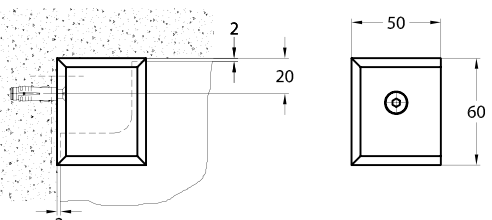

09162

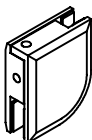
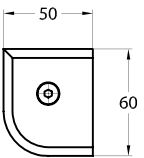
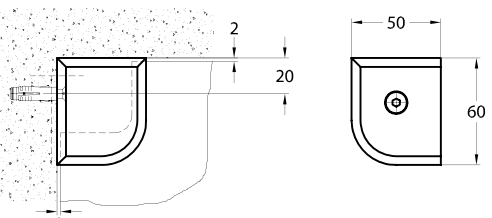

09262

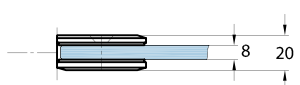

Glasbearbeitung // glass machining

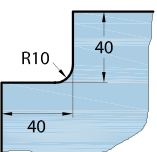

Besonderheiten // Features



Alle Angaben in mm // all details in mm

Chalet® AT

Art.Nr. // art.no. 09164, 09264

Halteklammer universal 90° // universal clamp 90°

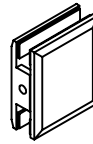
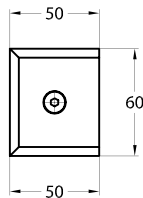
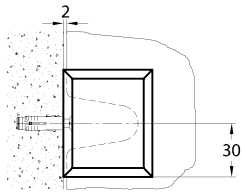

09164

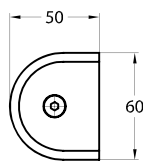
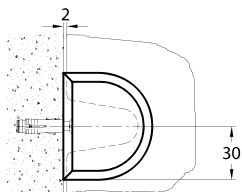

09264

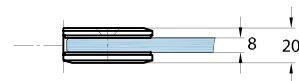

Glasbearbeitung // glass machining

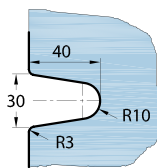

Besonderheiten // Features



Alle Angaben in mm // all details in mm

Art.Nr. // art.no. 09165, 09265

Halteklammer für Oberlicht- und Seitenteilbefestigung // clamp for transom mounting and side panel mounting

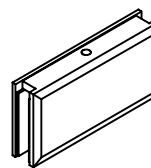
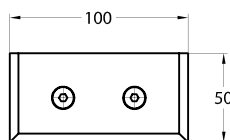
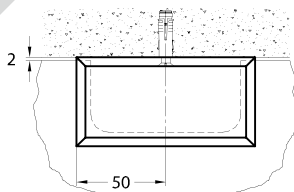

09165

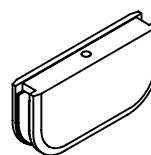
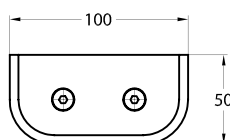
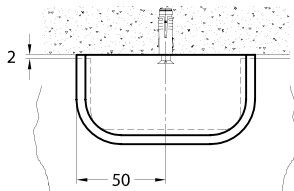

09265

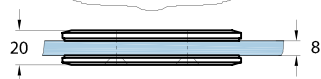

Glasbearbeitung // glass machining

Variante 1
Variation 1

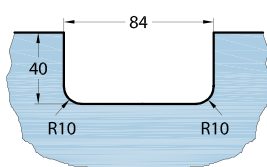

Variante 2
Variation 2

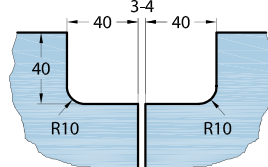

Besonderheiten // Features



Alle Angaben in mm // all details in mm

Chalet® AT

Art.Nr. // art.no. 09166, 09266

Halteklammer mit Verbindungsplatte mit Anschlagbuffer rechts // clamp with connector plate and buffer right

Glasbearbeitung // glass machining

Variante 1 Variation 1

Variante 2 Variation 2

Oberlicht transom

Tür door

Seitenteil side panel

Besonderheiten // Features

Alle Angaben in mm // all details in mm

Art.Nr. // art.no. 09167, 09267

Halteklammer mit Verbindungsplatte mit Anschlagbuffer links // clamp with connector plate and buffer left

Glasbearbeitung // glass machining

Variante 1 Variation 1

Variante 2 Variation 2

Oberlicht transom

Tür door

Seitenteil side panel

Besonderheiten // Features

Alle Angaben in mm // all details in mm

Chalet® AT

Art.Nr. // art.no. 09168, 09268

Halteklammer mit Verbindungsplatte mit Oberlichtbeschlag // *clamp with connector plate with transom mount*

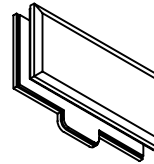
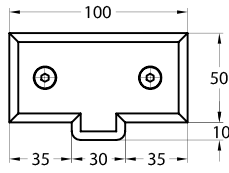
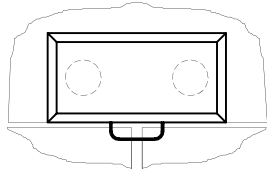

09168

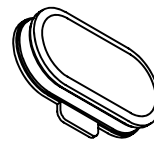
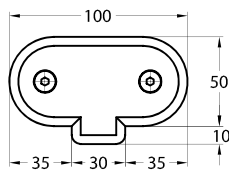
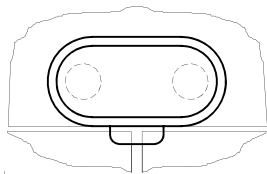

09268

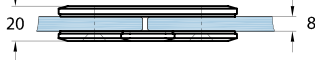

Glasbearbeitung // glass machining

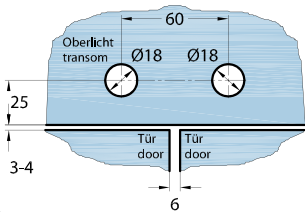

Besonderheiten // Features



Alle Angaben in mm // all details in mm

Art.Nr. // art.no. 09169, 09269

Halteklammer mit Verbindungsplatte Glas-Glas // *clamp with connector plate glass-glass*

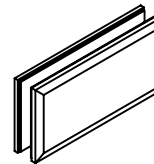
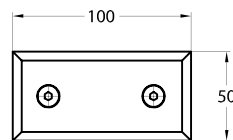
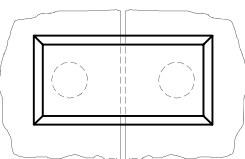

09169

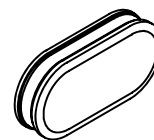
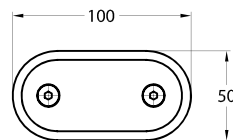
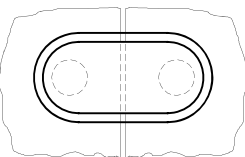

09269

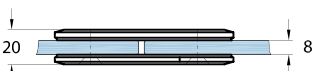

Glasbearbeitung // glass machining

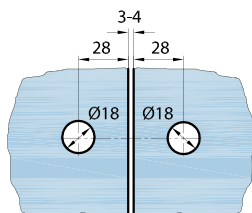

Besonderheiten // Features



Alle Angaben in mm // all details in mm

Chalet® AT

Art.Nr. // art.no. 09301, 09302

Anschlagwinkel für Türen // door stopper

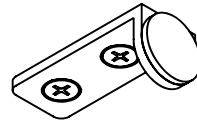
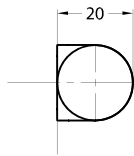
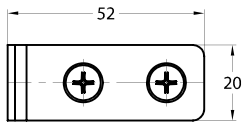

09301

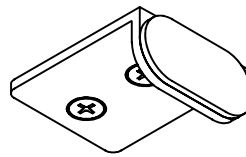
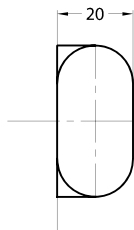
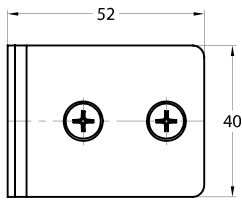

09302

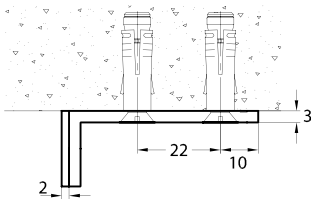

Besonderheiten // Features



Alle Angaben in mm // all details in mm

Oberflächenbeschreibung // surfaces / finishes

Codeziffer ¹⁾ no. of surface/finish ¹⁾	Oberfläche surface/finish
1	Aluminium unbehandelt <i>aluminium untreated</i>
10	silberfarbig eloxiert (ähnlich Oberfläche 46) <i>silver colour anodized (like finish 46)</i>
16	gebeizt, silberfarbig eloxiert <i>stained, silver-coloured anodised</i>
17	Alinox (Edelstahleffekt) <i>Alinox (stainless steel effect)</i>
19	Kunststoff transparent <i>transparent plastics</i>
20	Zinkdruckguß unbehandelt <i>zinc diecasting</i>
27	Kunststoff weiß <i>white plastics</i>
28	Kunststoff schwarz <i>black plastics</i>
29	Kunststoff grau <i>grey plastics</i>
31	glanzverchromt // <i>bright chrome</i>
34	aluminiumfarben pulverbeschichtet <i>powder-coated in aluminium-colour</i>
36	glanzvernickelt // <i>bright nickel</i>
37	glanzvernickelt, Klarlack // <i>bright nickel, clear varnish</i>
41	Stahl verzinkt // <i>steel zinc-plated</i>
46	mattverchromt // <i>satin chrome</i>
47	geschliffen, mattverchromt (Edelstahleffekt) <i>grounded, satin chrome (stainless steel effect)</i>
51	mattvernickelt // <i>satin nickel</i>
53	VA-Finish matt, mit Klarlack <i>brushed stainless steel finish, clear varnish</i>
55	KL-megla® Nickel gebürstet // <i>KL-megla® brushed nickel</i>
61	vergoldet // <i>gold-plated</i>
62	Edelmessing // <i>fine brass</i>
80	RAL 8019 braun pulverbeschichtet <i>RAL 8019 brown powdercoated</i>
81	RAL 9005 schwarz pulverbeschichtet <i>RAL 9005 black powdercoated</i>
82	RAL 9010 weiß pulverbeschichtet <i>RAL 9010 white powdercoated</i>
83	RAL 9016 verkehrsweiß pulverbeschichtet <i>RAL 9016 white powdercoated</i>
90	poliert // <i>polished</i>
91	matt gebürstet // <i>brushed</i>
93	Edelstahl unbehandelt // <i>stainless steel untreated</i>
97	Edelstahl drehblank <i>stainless steel fine turned</i>

¹⁾ Wichtig: Die Codeziffer ist Bestandteil der Bestell-Nr.
Attention: the surface / finish no. is part of the order no.!

Allgemeine Informationen // general information



Basismaterial: rostfreier Edelstahl V2A
Base material: stainless steel



Basismaterial: rostfreier Edelstahl V4A
Base material: stainless steel



Basismaterial: hochwertiger, rostfreier Edelstahl
Base material: high quality stainless steel



Basismaterial: Messing
Base material: brass



Basismaterial: Aluminium
Base material: aluminum



Basismaterial: Magnesium
Base material: magnesium



Basismaterial: Kunststoff
Base material: plastic



Beschlag bei normaler Handhabung wartungsfrei
Maintenance-free fitting through normal handling



Beschlag mit exzentrischer Höhenverstellbarkeit
Hinge with eccentrical height adjustability



Beschlag mit horizontaler und vertikaler Verstellbarkeit
Hinge with horizontal and vertical adjustability



Beschlag mit horizontaler Verstellbarkeit
Hinge with horizontal adjustability



Beschlag mit vertikal Verstellbarkeit
Hinge with vertical adjustability



Beschlag mit patentierter stufenloser Nullpunkt-Verstellung
Hinge with patented continuous adjustable 0-position



Beschlag mit stufenloser Nullpunkt-Verstellung
Hinge with continuous adjustable 0-position



Beschlag mit flächenbündiger Verschraubung auf der Rückseite
Hinge with screw connection flush to surface on the back



Türband mit Hebe-Senk Technik
Door hinge with lifting mechanism



Duschtürband für durchlaufendes Dichtprofil (Bypass-System)
Shower door hinge for continuous seal (By-pass System)



Beschlag mit Klebtechnik: entwickelt in Zusammenarbeit mit der Technischen Universität Dresden.
Hinge with adhesion technology: developed in cooperation with the Technische Universität Dresden.



Patentierter Schließtechnik, Türband mit selbstschließender Funktion
patented closing function, door hinge with self-closing Funktion



Schließtechnik, Türband mit selbstschließender Funktion
closing function, door hinge with self-closing funktion



Schließtechnik, Türband mit selbstschließender Funktion
closing function, door hinge with self-closing funktion



Allgemeine bauaufsichtliche Zulassung durch DIBt
Approved by the building authorities of DIBt



„Geprüfte Sicherheit“ durch den TÜV Rheinland in Kombination mit der ID-Nummer
Security tested by the German TÜV Rheinland in combination with the ID-number



„Bauart geprüft“ durch den TÜV Rheinland in Kombination mit ID-Nummer
„Type approved“ by the German TÜV Rheinland in combination with the ID-number



Konformität mit den Bestimmungen der EU-Richtlinien
Conformity with and adherence to the EU-directives

Hinweise:

T gilt nur für Türe // applies only to door
S gilt nur für Seitenteil // apply only to side panel

Lieferung // Delivery

- standardmäßig lieferbar // standard available
- ⊗ für Lieferung sind Angaben des Kunden erforderlich // details by the client are necessary for delivery
- für Lieferung ist Rücksprache erforderlich // consultation is necessary for delivery

Allgemeine Hinweise // general information

Anwendungsbereich unserer Produkte // Application range of our products

Für die Anwendung im Bereich Schwimmbad, Sauna, Salzwasser oder hochfrequentierter Bereich bitten wir um Rücksprache.
For application in swimming pool, sauna or salt-water areas, as well as in high frequented areas, consultation necessary.

Maßstab // actual size

Maßstab ist nicht 1:1 // actual size is not 1:1

Befestigungsmaterialien // materials for mounting

Die statisch notwendigen Befestigungsmaterialien für die Montage der Beschläge an den tragenden Baukörper müssen vom Verarbeiter bestimmt werden.

Befestigungsschrauben für die Wandbefestigung werden grundsätzlich nur auf Wunsch und gegen zusätzliche Berechnung mitgeliefert. Die Verwendbarkeit der Schrauben muss grundsätzlich vom Verarbeiter geprüft werden. Wir übernehmen ausdrücklich hierfür keine Haftung. Die Montage sollte nur von einem Fachmann durchgeführt werden.

The statistically necessary mounting materials for the mounting of the fittings on the load-bearing structure must be determined by the persons responsible for the mounting. Fastening screws for attachment to the wall will as a rule only be delivered upon request and at extra cost. The suitability of the screws is to be determined by the persons responsible for the mounting. We expressly disclaim liability therefore. The mounting should only be carried out by an expert.

Konstruktion und Einbau // construction and fitting

Als Konstruktions- und Einbauvorlage für Duschtür-Systeme, nutzen Sie bitte unsere Software eDesign „Duschen nach Maß“.

For construction and fitting of shower door systems make use of our software eDesign „Duschen nach Maß“

Ihre Bestell-Nr. setzt sich wie folgt zusammen // our order number is made up of

Art.-Nr- (5-stellig)
art.no. (5-Digit)

Codeziffer
number of surface/finish



• Form, Inhalt und Struktur dieses Katalogs sind urheberrechtlich geschützt.
Form, content and structure of this catalog are copyrighted.

• Fertigungstechnische Toleranzen und Änderungen sind uns vorbehalten.
We explicitly reserve the right of production tolerances and changes in our products.

• Alle Angaben ohne Gewähr.
All informations without guarantee.

KL-megla GmbH
Wecostraße 15
53783 Eitorf
Germany

Phone + 49 (0) 22 43 - 9 23 00-0
Fax + 49 (0) 22 43 - 9 23 00-36
info@KL-megla.com
www.KL-megla.com



KL-megla®

Wecostrasse 15
53783 Eitorf, Germany

Phone +49 (0) 2243 - 9 23 00 - 0
Fax +49 (0) 2243 - 9 23 00 - 36

KL-megla® Online

info@KL-megla.de
www.KL-megla.de
www.shop.KL-megla.de

