

System: Doppellaufschiene obenlaufend, minimale Einbauhöhe, Deckenmontage, für 1 Alurahmentüre bis 100 kg

System: Dual top running track, minimum installation height, ceiling mounting, for 1 aluminium framed door up to 100 kg

Système: Rail de roulement double à roulement en haut, hauteur d'installation mini, montage au plafond, pour 1 porte à cadre en aluminium jusqu'à 100 kg

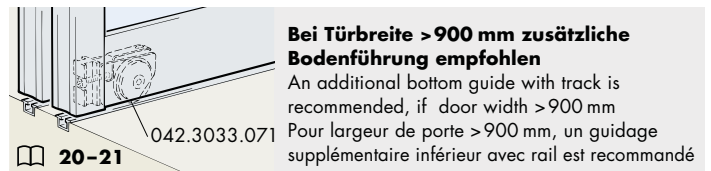
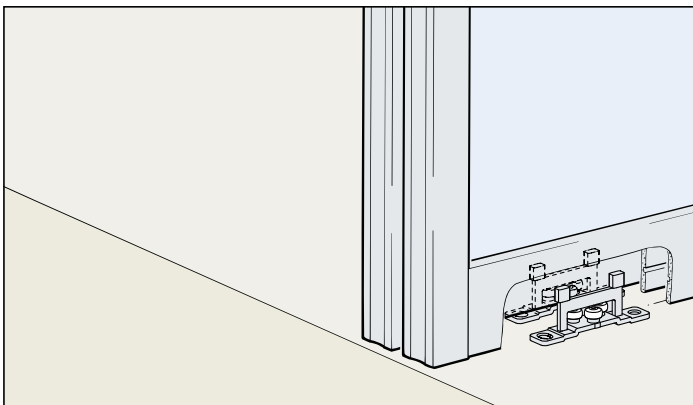

Einbaubeispiele / Mounting examples / Exemples de montage

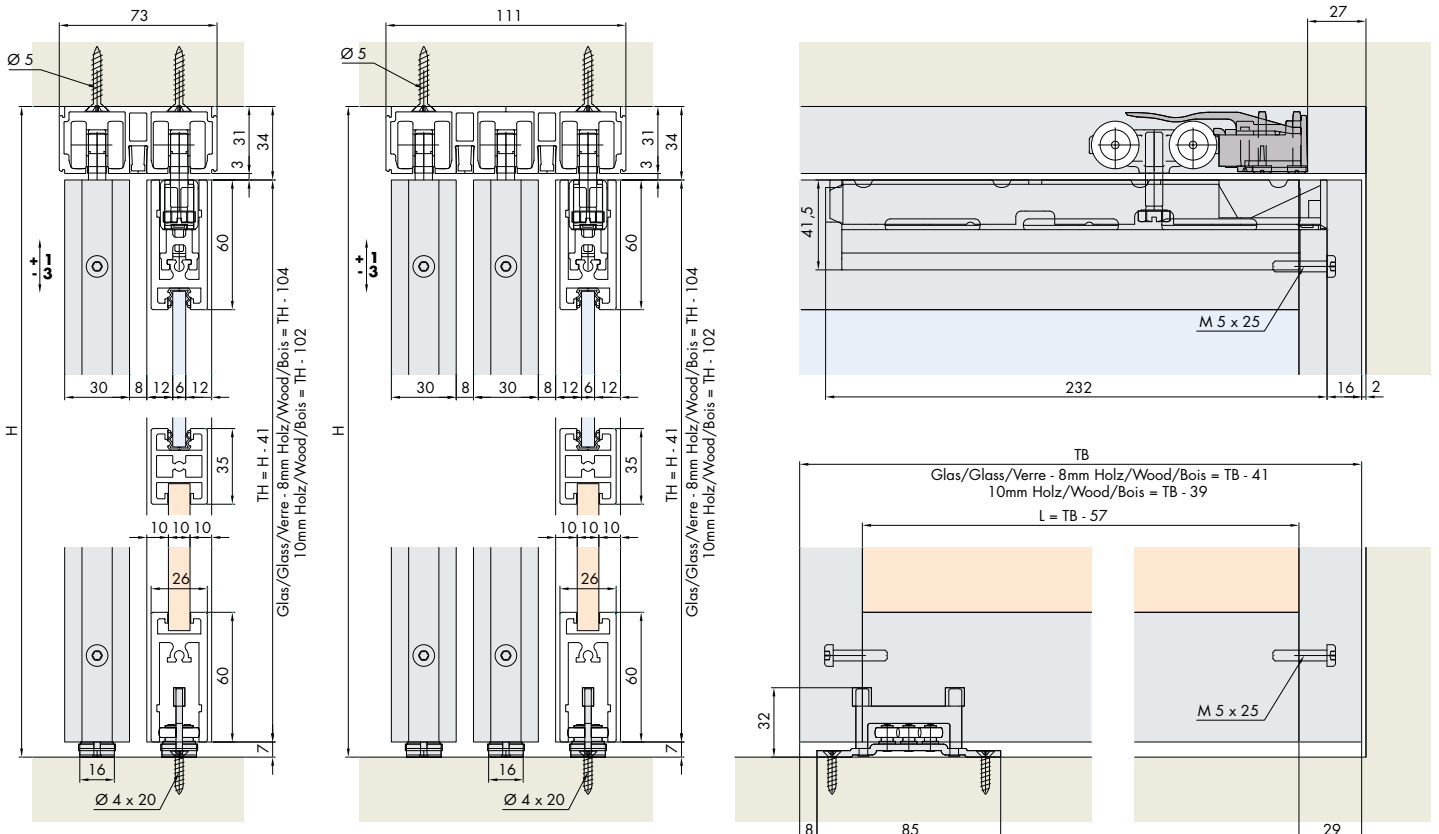

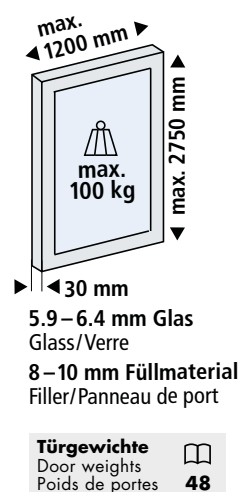

Garnituren / Sets / Garnitures

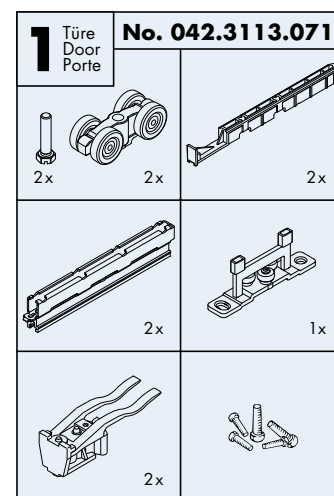

Zubehör / Accessories / Accessoires

Einfachlaufschiene, Alu, eloxiert, gelocht

Running track, aluminium, anodized, pre-drilled
Rail de roulement, en alu, anodisé, perforé

Gr./Size

Art. No.

2000 mm	057.3016.201
2500 mm	057.3016.251
6000 mm	057.3016.601

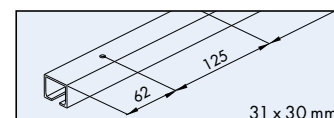
**Doppellaufschiene, Alu, eloxiert, gelocht**

Dual running track, aluminium, anodized, pre-drilled
Rail de roulement double, en alu, anodisé, perforé

2500 mm	042.3002.250
3500 mm	042.3002.350
6000 mm	042.3002.600

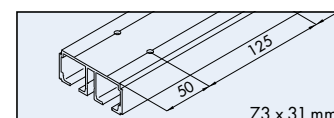
**Dreifachlaufschiene, Alu, eloxiert, gelocht**

Triple running track, aluminium, anodized, pre-drilled
Rail de roulement triple, en alu, anodisé, perforé

2500 mm	042.3084.250
3500 mm	042.3084.350
6000 mm	042.3084.600

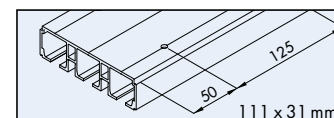
**Abdeckprofil, Alu, eloxiert, zu 042.3002/042.3084**

Cover profile, aluminium, anodized, for 042.3002/042.3084
Profil de recouvrement, en alu, anodisé, pour 042.3002/042.3084

2500 mm	042.3086.250
3500 mm	042.3086.350
6000 mm	042.3086.600

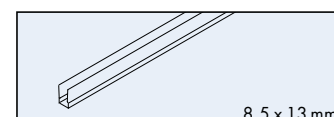
**Rahmenprofil horizontal, Alu, eloxiert**

Frame profile horizontal, aluminium, anodized
Profil cadre horizontal, en alu, anodisé

2500 mm	042.3000.250
3500 mm	042.3000.350
6000 mm	042.3000.600

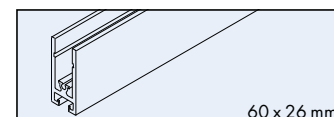
**Rahmenprofil vertikal, Alu, eloxiert**

Frame profile vertical, aluminium, anodized
Profil cadre vertical, en alu, anodisé

2500 mm	042.3001.250
3000 mm	042.3001.300
6000 mm	042.3001.600

**Rahmenprofil mit Griff vertikal, Alu, eloxiert**

Frame profile with handle vertical, aluminium, anodized
Profil cadre avec poignée verticale, en alu, anodisé

2500 mm	042.3083.250
3000 mm	042.3083.300
6000 mm	042.3083.600

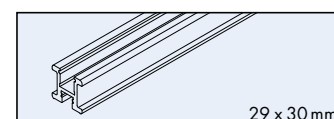
**Rahmensprosse, Alu, eloxiert, für Frontunterteilung**

Frame profile, aluminium, anodized, for front subdivision
Meneau cadre, en alu, anodisé, pour division frontale

2500 mm	042.3007.250
3500 mm	042.3007.350
6000 mm	042.3007.600

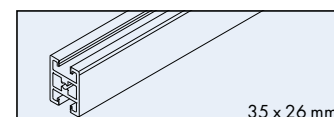

Rahmen- und Sonderzubehör / Frame- and special accessories / Accessoires cadre et spéciaux: 44–46

Technische Daten / Technical data / Caractéristiques techniques: 49