



Reflectiv[®]
Window Films

FILMS ADHÉSIFS
DÉCORATIFS

DECORATIVE
WINDOW FILMS

LÁMINAS ADHESIVAS
DECORATIVAS

PELLICOLE ADESIVE
DECORATIVE

DEKORATIONSFOLIEN





POSE FACILE • EASY TO APPLY • SE COLOCA FÁCILMENTE • APPLICAZIONE FACILE

- Personnalisent les vitrages
- Préservent l'intimité
- Excellente restitution de la lumière
- Grand choix de designs
- Traitement anti-rayures
- Mise en œuvre rapide
- Sans entretien
- S'enlèvent facilement

- Personalize glazing
- Keep the privacy
- Keep the brightness
- Large range of designs
- Anti-scratch
- Easy to apply
- Require no maintenance
- Can be easily removed

- Personalizan los cristales
- Preservan la intimidad
- No altera la luminosidad
- Gran selección de diseños
- Tratamiento anti-scratch
- Colocación rápida
- Sin necesidad de mantenimiento
- Se quita fácilmente

- Personalizzano i vostri vetri
- Preservano la privacy
- Non alterano la luminosità
- Grande selezione di disegni grafici
- Trattamento anti-scratch
- Applicazione veloce
- Non richiedono manutenzione
- Si tolgono facilmente

↙ CARACTÉRISTIQUES / FEATURES / CARACTERÍSTICAS / CARATTERISTICHE /

Support : Polyester
Adhésif :
 Polymère acrylique 13gr/m²
Protecteur : Polyester siliconé
Épaisseur : 23 microns
Application : Interne
Résistance thermique :
 de -20°C à 80°C
Température d'application :
 Minimum 5°C
Classement au feu : M1
Normes : Euroclasses

Support: Polyester
Adhesive:
 Acrylic polymer 13 gr/m²
Protector: Silicone polyester
Thickness: 23 microns
Application: Internal
Thermal resistance:
 -20°C to 80°C
Application Temperature:
 Minimum 5°C
Fire rating: M1
Standards: Euroclasses

Soporte: Poliéster
Adhesivo:
 Polímero acrílico 13gr/m²
Protectores: poliéster siliconado
Grueso: 23 micras
Aplicación: Interna
Resistencia térmica:
 -20°C a 80°C
Temperatura de colocación:
 Mínimo 5°C
Clasificación al fuego: M1
Normas: Euroclasses

Supporto : poliestere
Adesivo :
 acrilico polimerico 13gr/m²
Protettore : Poliesterone siliconato
Spessore : 23 microns
Applicazione : interna
Resistenza termica :
 da -20°C a 80°C
Temperatura per applicazione:
 Minimo 5°C
Classificazione al fuoco: M1
Norme: Euroclasses



ILE • LEICHT ANZUBRINGEN

- *Personalisieren das Glas*
- *Schützen Sie Ihre Verglasung vor neugierigen Blicken*
- *Ausgezeichnete Lichtdurchlässigkeit*
- *Große Auswahl an Designs*
- *Anti-Kratzer Beschichtung*
- *Schnelle Anbringung*
- *Ohne Pflege*
- *Leicht zu entfernen*

EIGENSCHAFTEN

Fassung: Polyester

Kleber:

Akryl-Polymer 13g/m²

Schutz: Polyester Silikon

Dicke: 23 micron

Anwendung: Intern

Thermische Resistenz:

-20°C bis 80°C

Anwendungstemperatur:

mindestens 5°C

Feuereinstufung: M1

Standard: Euroclasses

Reflectiv®

Window Films

Flashez ce code pour accéder à une vidéo de pose ou retrouvez-la sur : www.reflectiv.com

Flash this code to access an installation video or find it on: www.reflectiv.com

Haga el flash de este código para acceder al video de colocación o encuéntrela en www.reflectiv.com

Facendo un flash a questo codice potete accedere al video di applicazione o cercatelo su: www.reflectiv.com

Um auf ein Installationsvideo zuzugreifen scannen Sie diesen Code oder gehen Sie auf www.reflectiv.com



SOMMAIRE

P 4-5	INT 110/120
P 6-7	INT 200/256
P 8-9	INT 090-100/212
P 10-11	INT 213/230
P 12-13	INT 234/236-237
P 14-15	INT 245/288
P 16-17	INT 289/290
P 18-19	INT 320/333
P 20-21	INT 343/420
P 22-23	INT 435/450
P 24-25	INT 455/460
P 26-27	INT 468/470
P 28-29	INT 480/490
P 30-31	INT 500/510
P 32-33	INT 520/530
P 34-35	INT 540/549
P 36-37	INT 560/606
P 38-39	Vitraux
P 40-43	Couleur

NOUVEAUTÉ

110

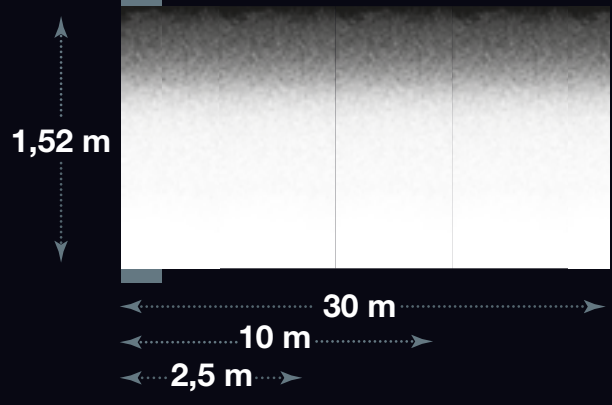

Film blanc dégradé
White decreasing

120

NOUVEAUTÉ

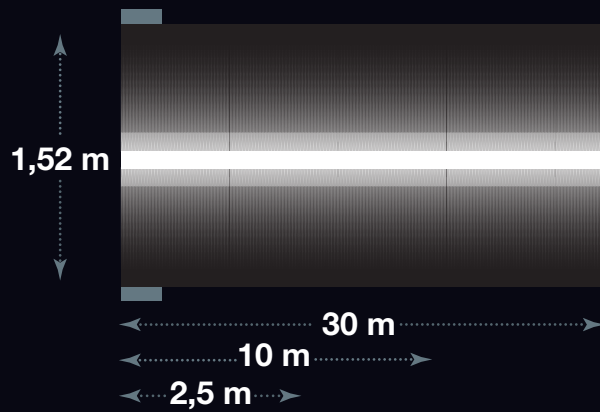

Bande centrale diffusante
Diffusing central strip

200

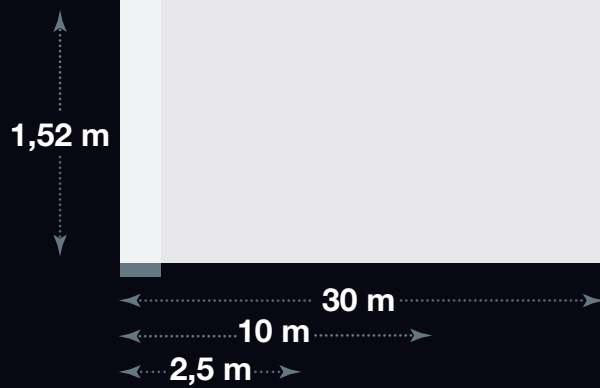

Dépoli blanc
White frosted

256

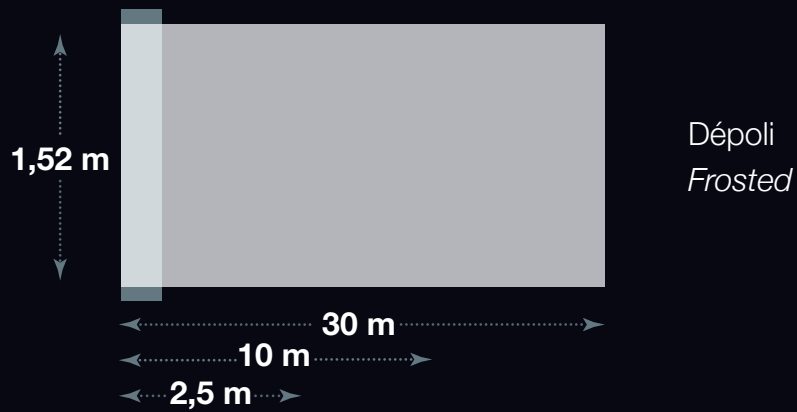

090-100



1,22 m

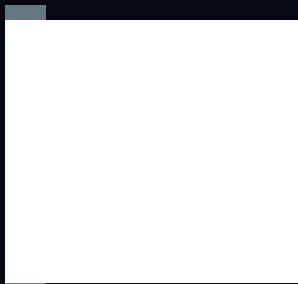

INT 090

Film blanc uni
Solid white

30 m
10 m
2,5 m

1,22 m



INT 100

Film blanc dégradé
White decreasing

30 m
10 m
2,5 m

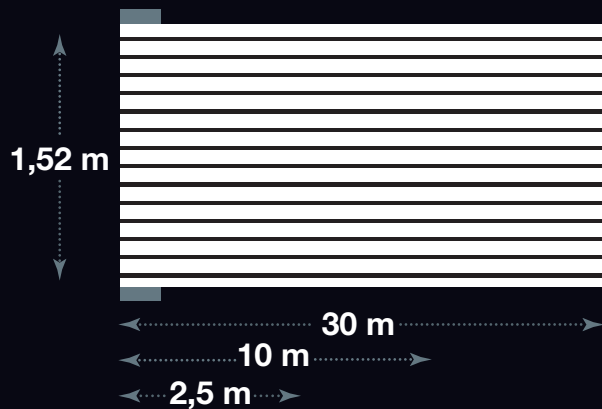

Bandes blanches de 13 mm
White stripes of 13 mm

213

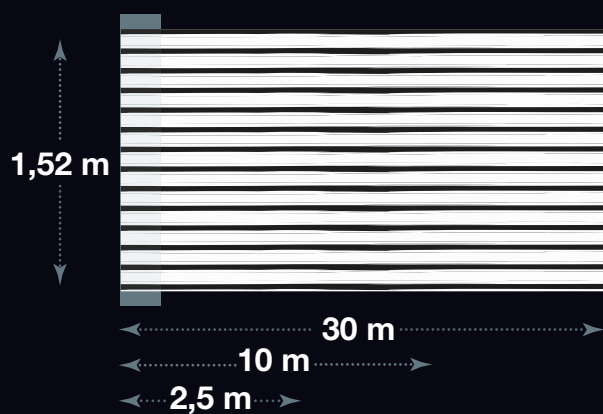

Bandes dépolies de 13 mm
Frosted stripes of 13 mm

230

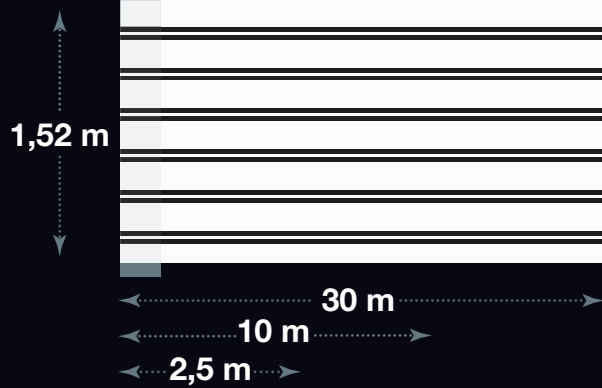
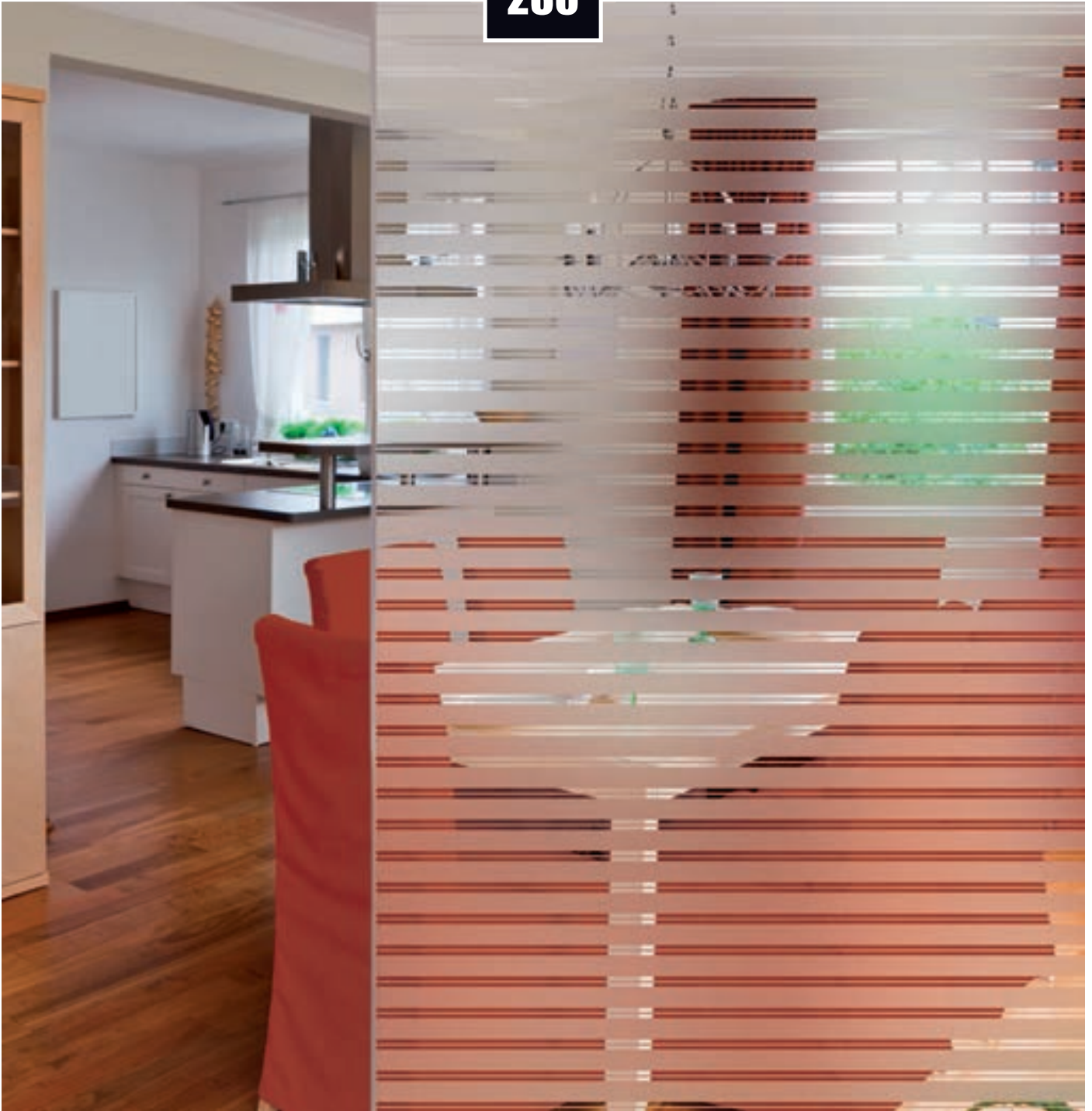

Bandes dépolies de 30 / 3 mm
Frosted stripes of 30 / 3 mm

234

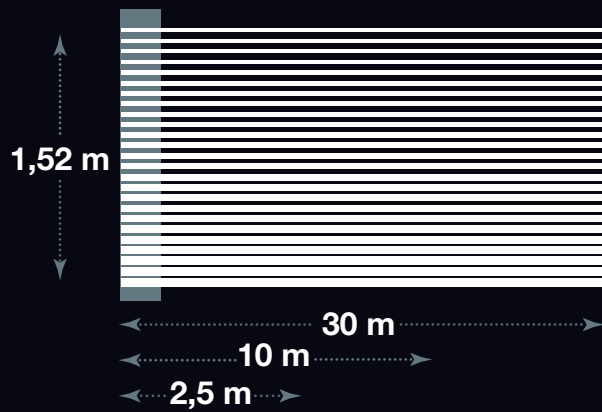

Bandes blanches dégradées
Decreasing white stripes

236•237

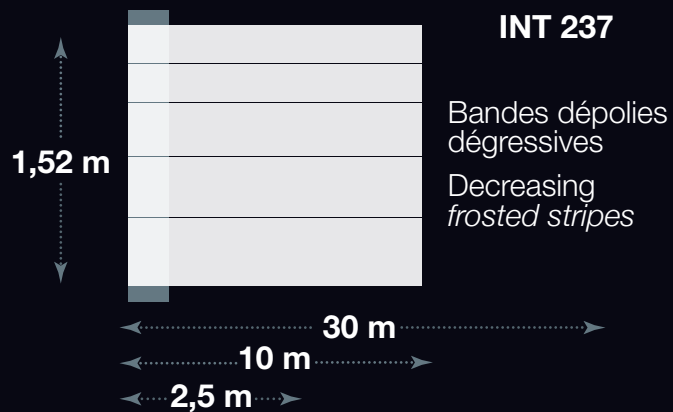
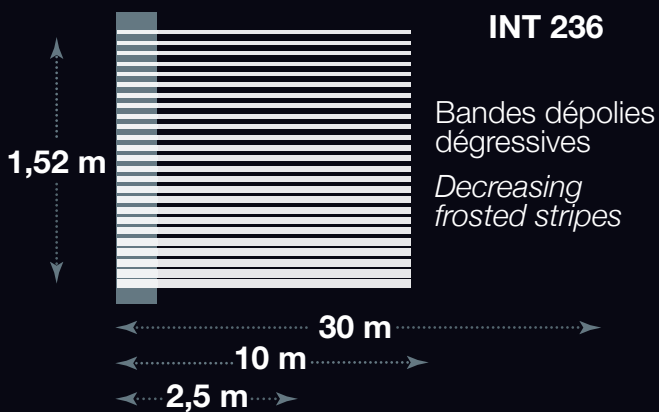

245

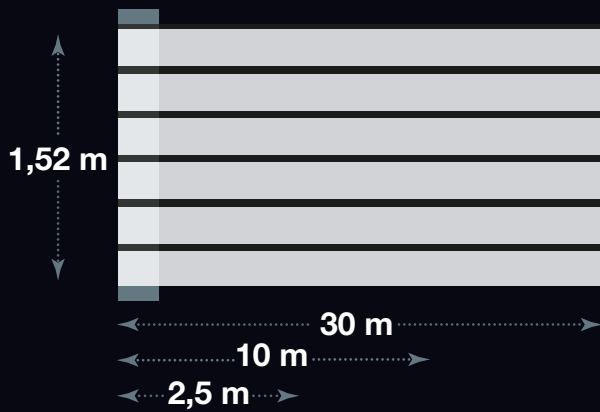
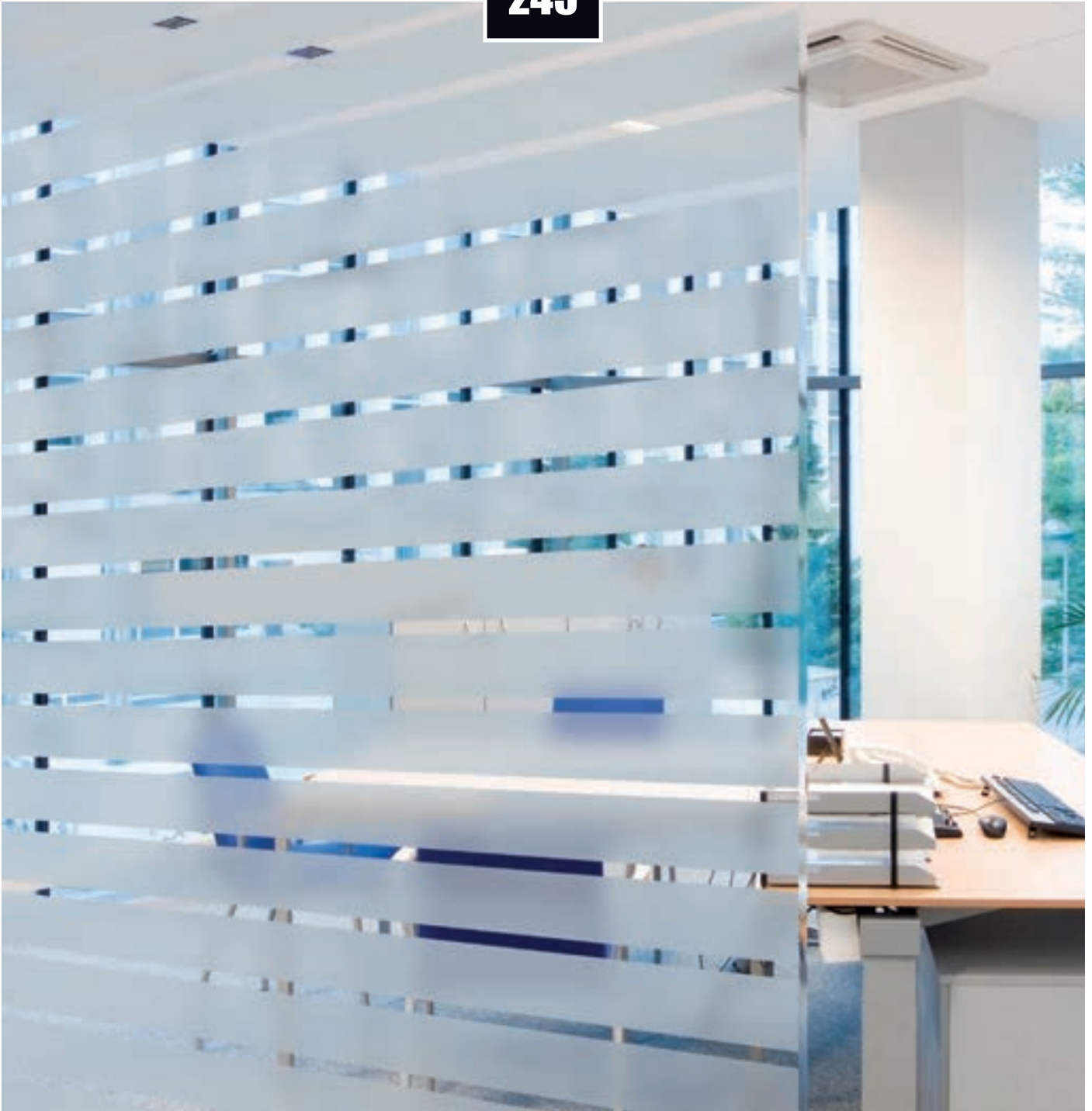

Bandes dépolies de 45 mm
Frosted stripes of 45 mm

288

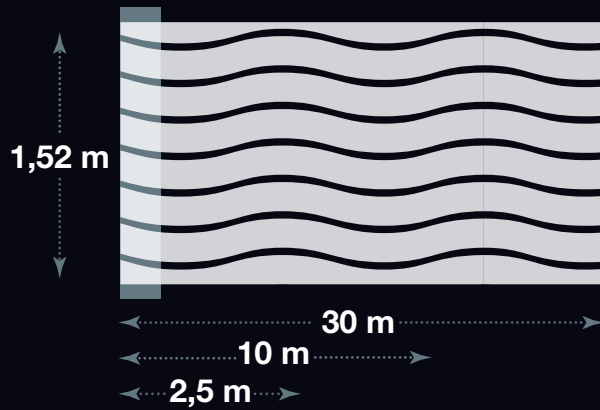
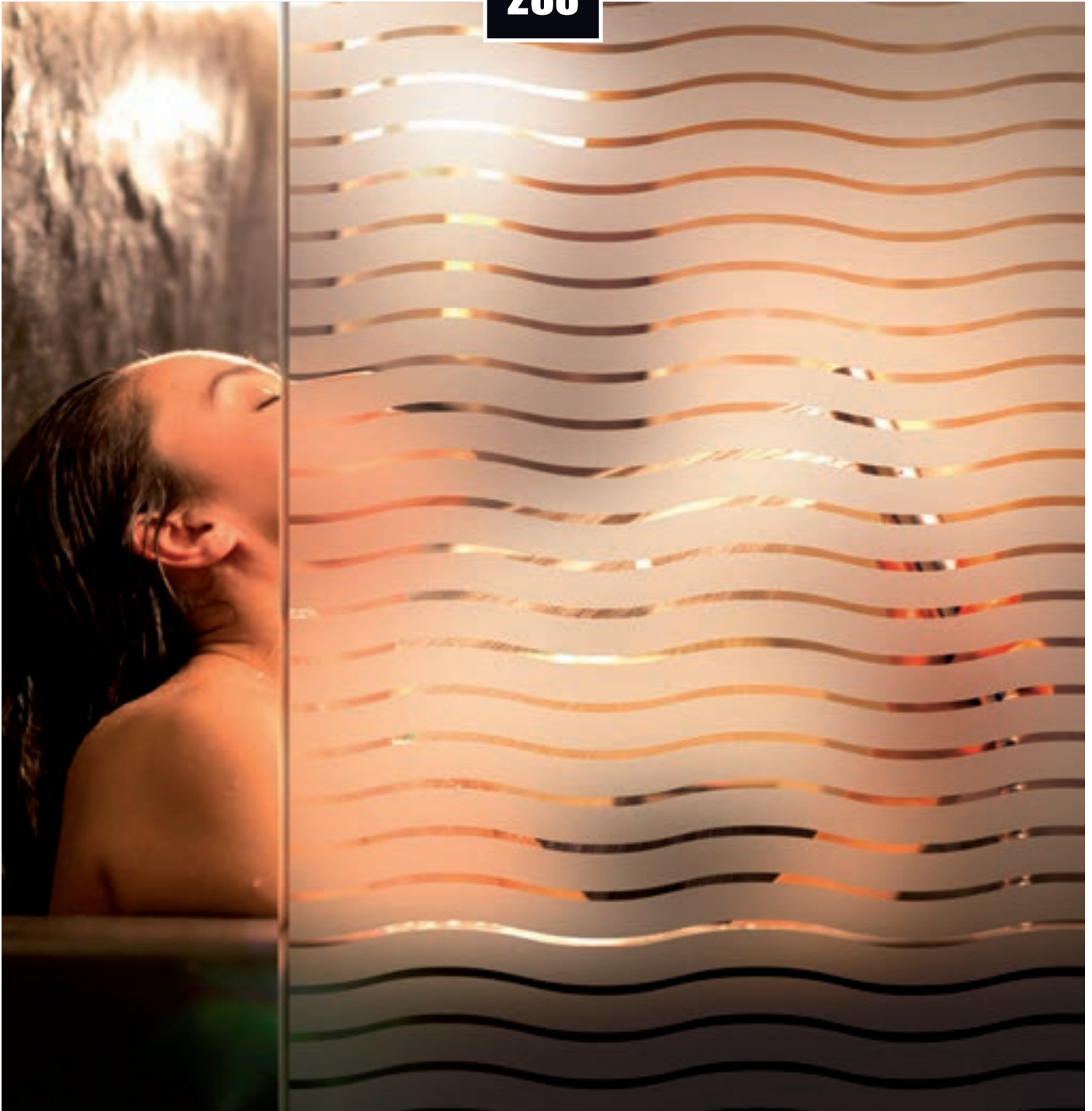

Vagues dépolies de 45 mm
Frosted waves of 45 mm

289

NOUVEAUTÉ

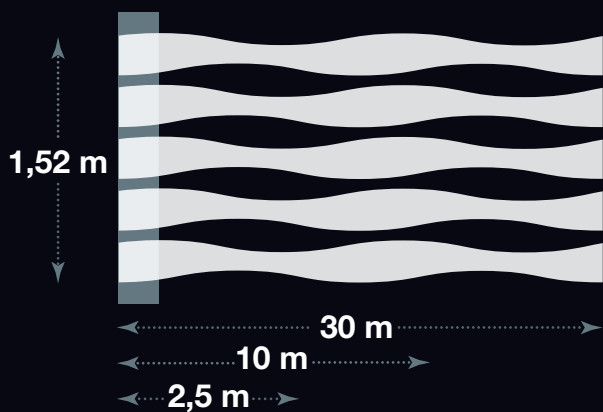

Vagues dépolies de 50 mm
Frosted waves of 50 mm

290

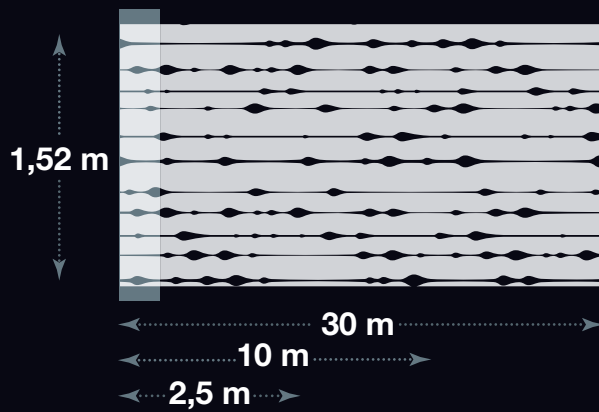

Dépoli gouttes de miel
Frosted drops of honey

320

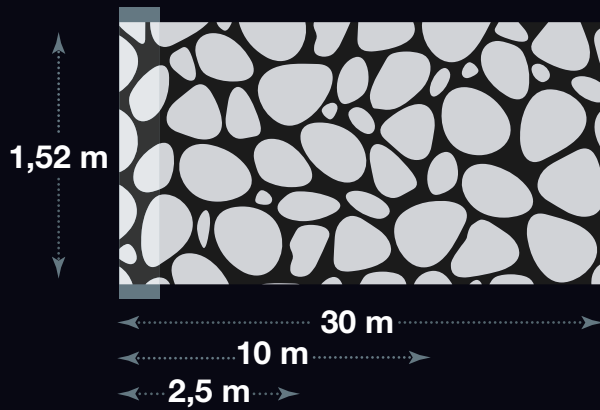
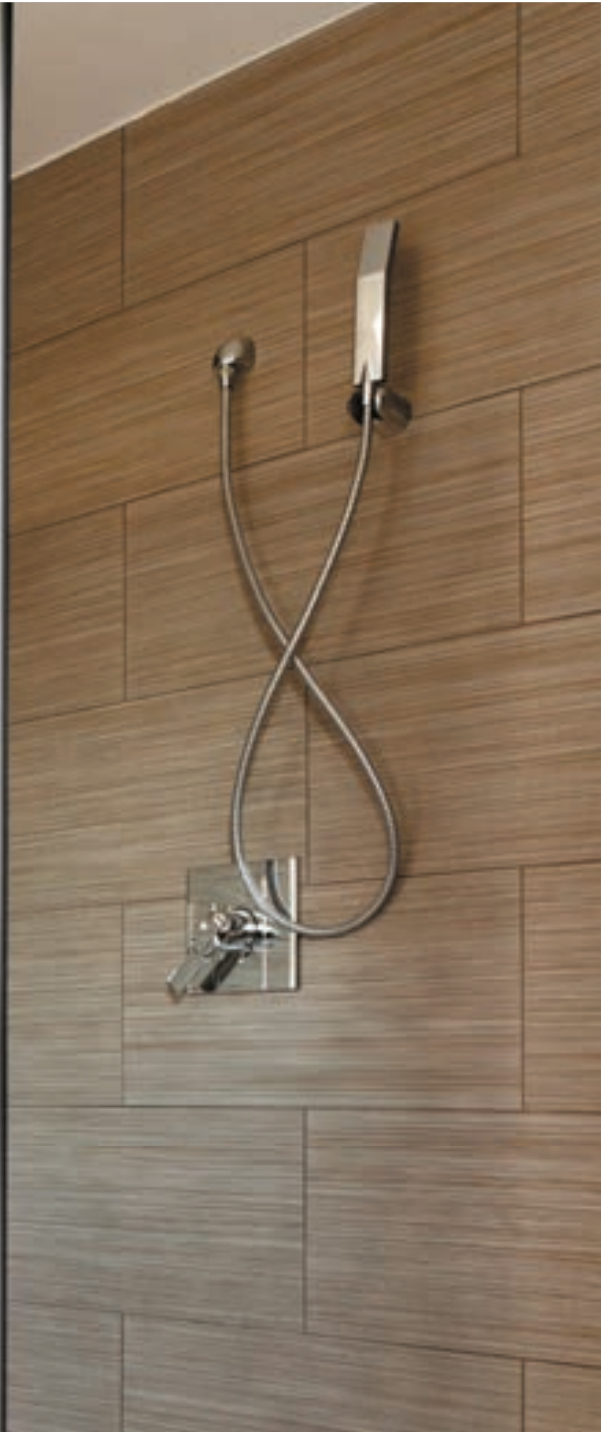
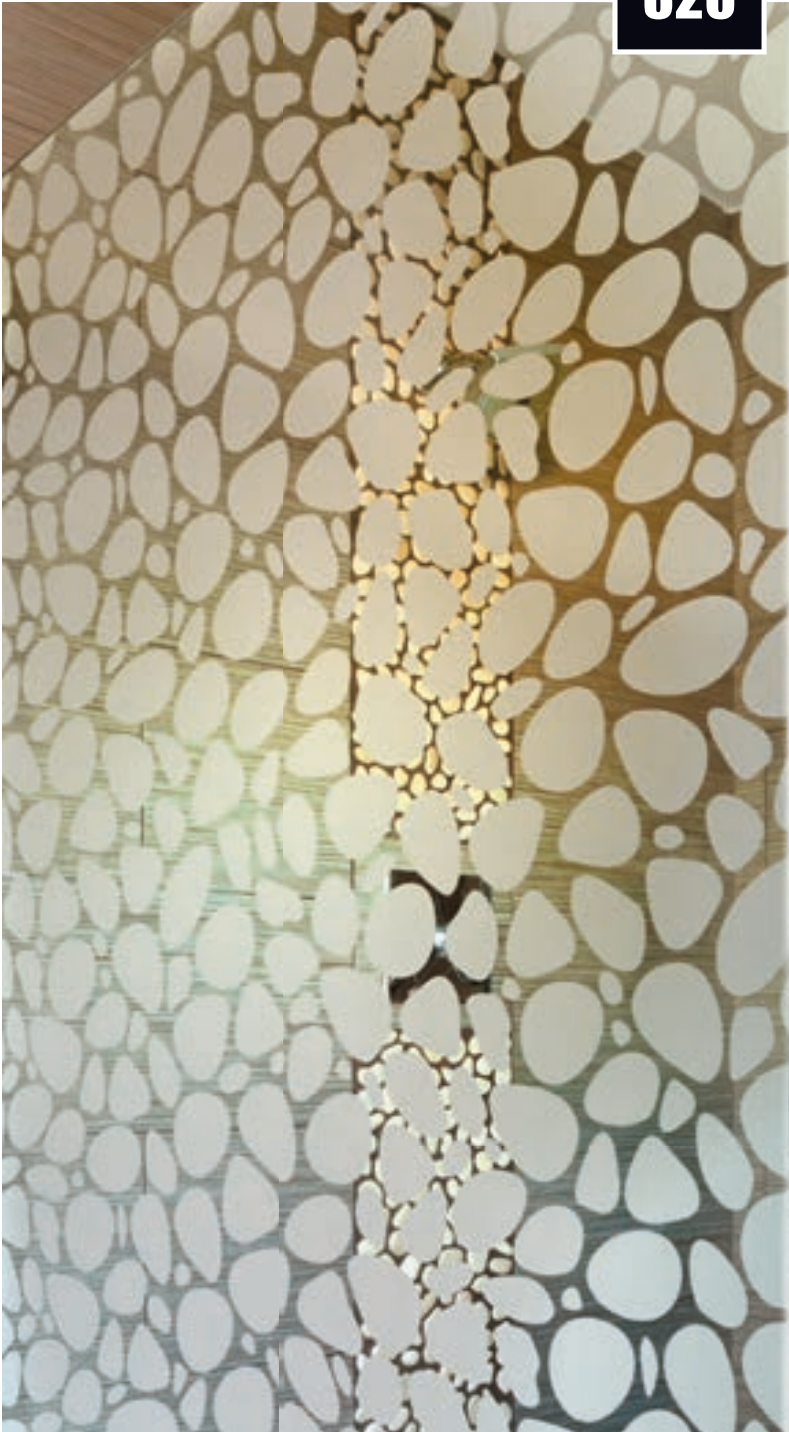

Galets
Stones

333

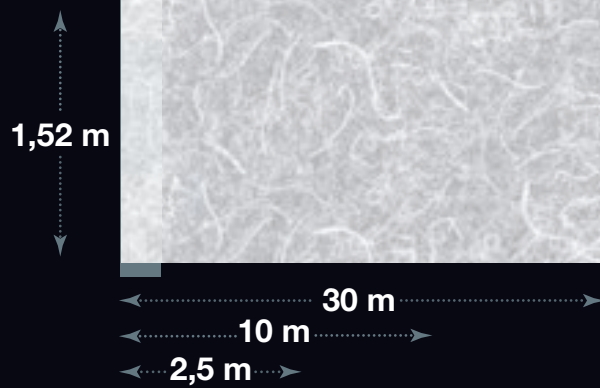

Cocoon

343

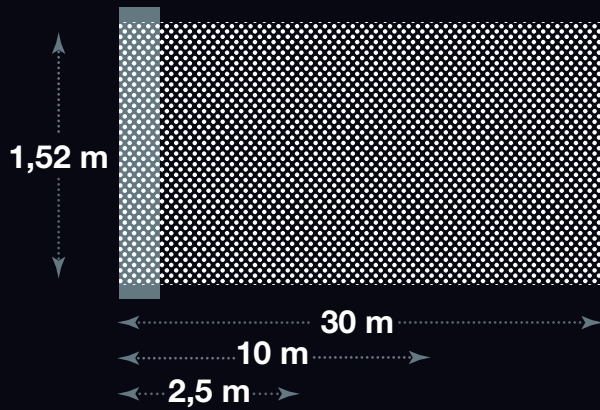
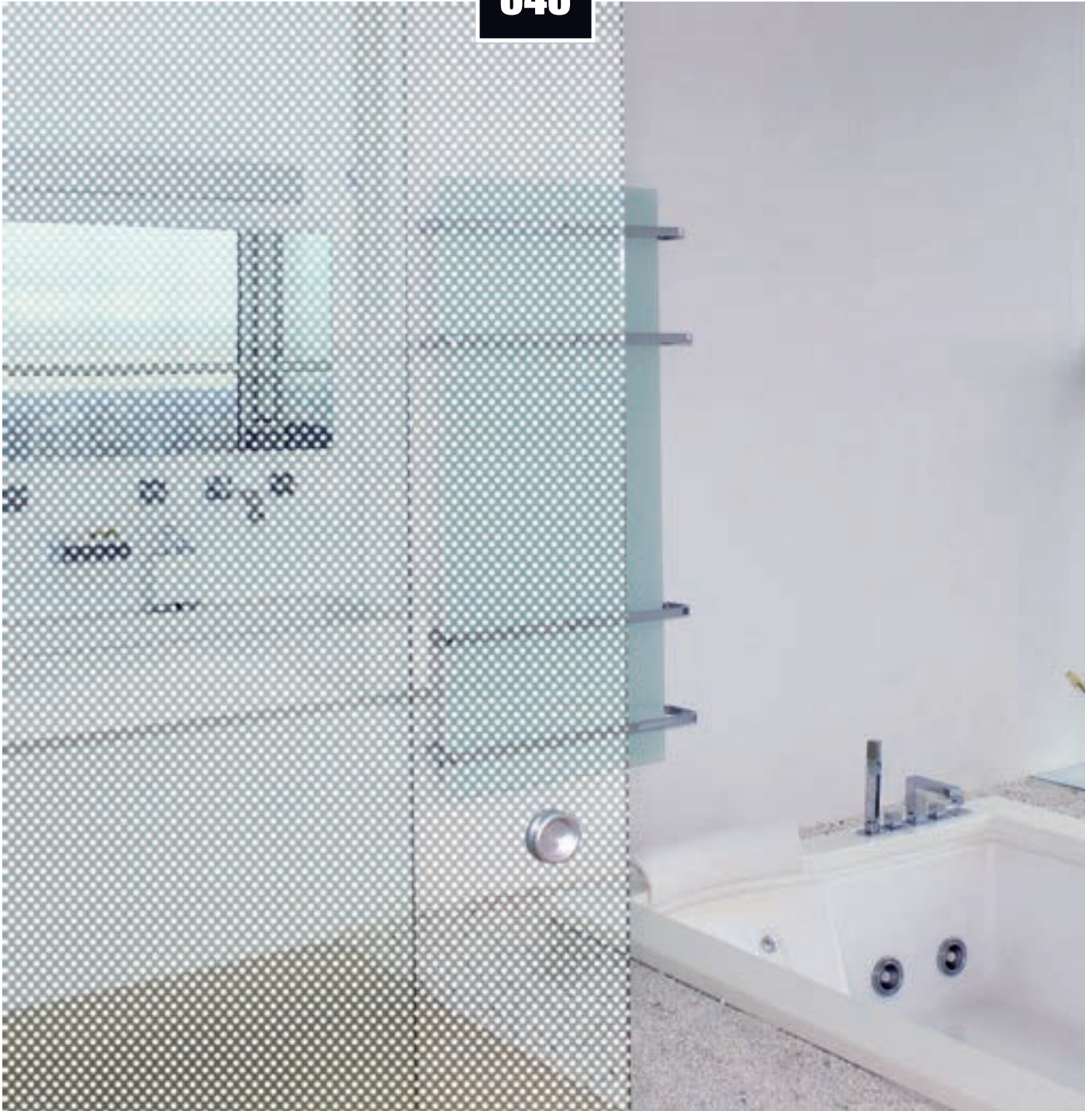

Points blancs de 3 mm
White dots of 3 mm

420

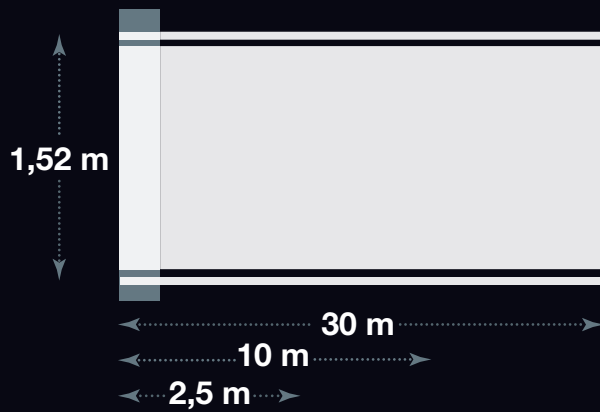

Dépoli avec 2 bandes
Frosted with 2 stripes

435

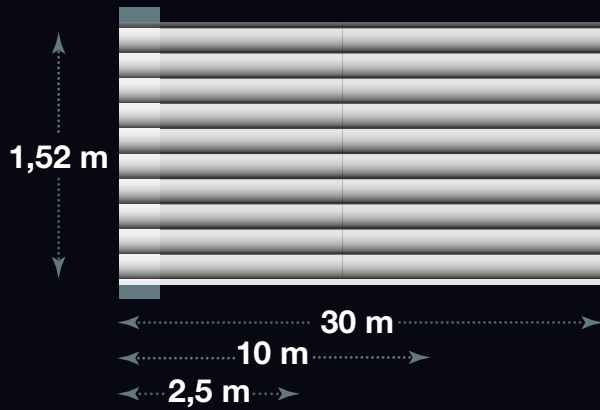
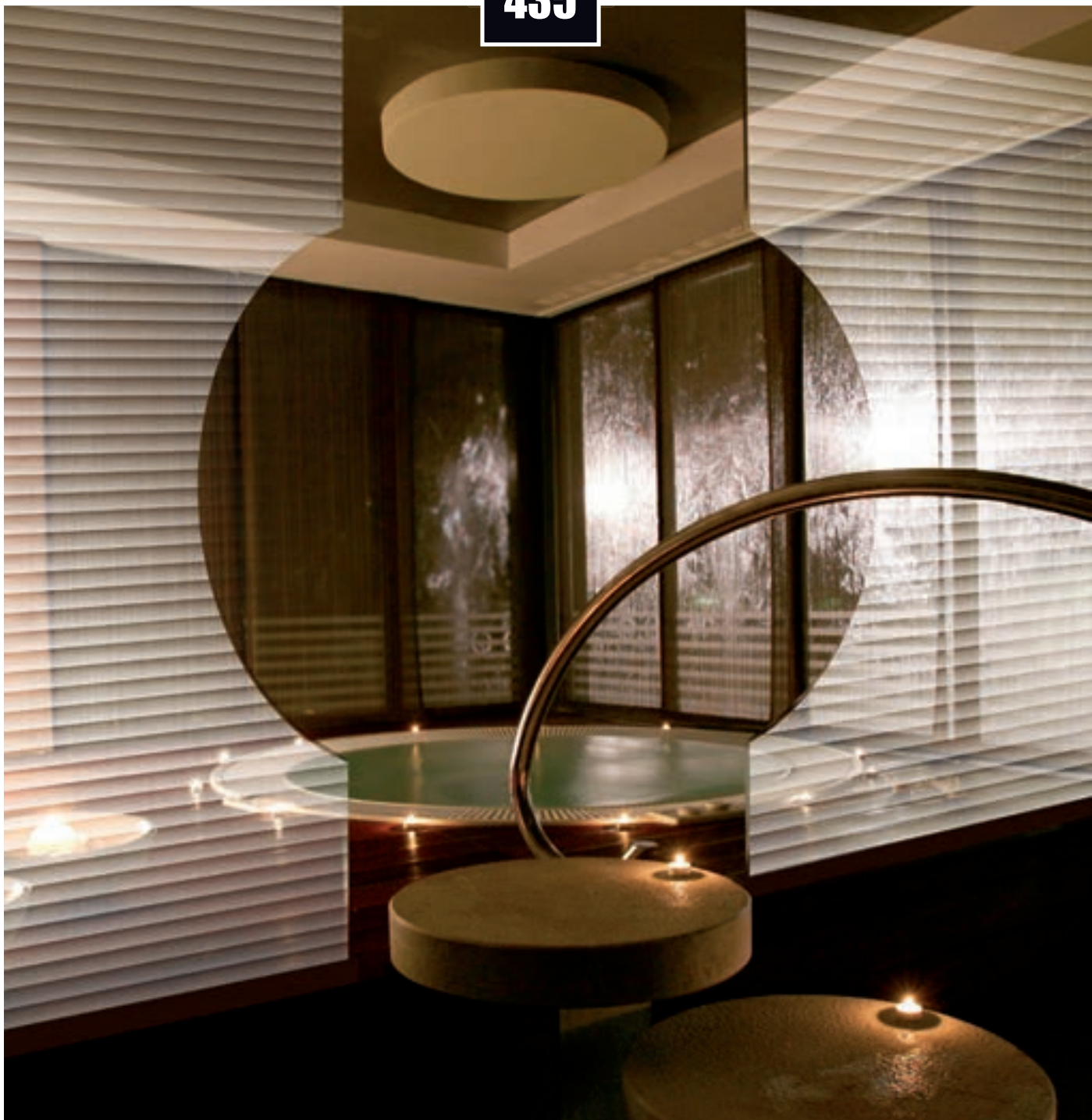

Bandes blanches tramées
White stripes of 43 mm

450

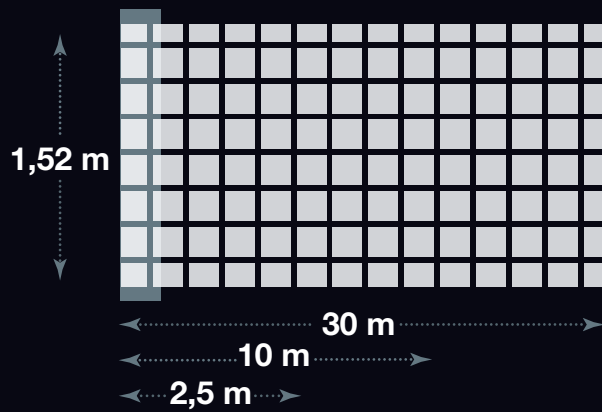
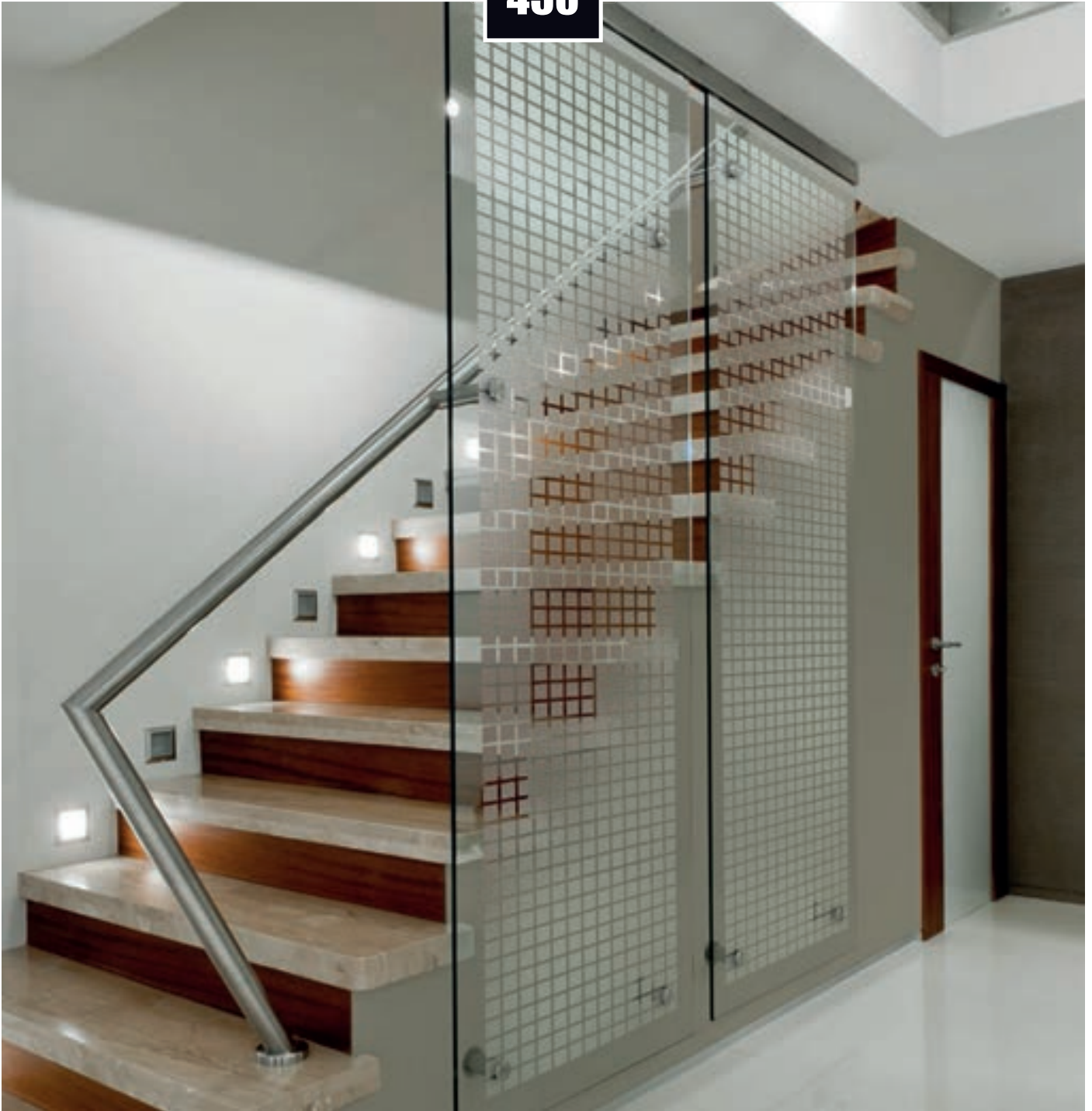

Carrés dépolis de 45 mm
Frosted squares of 45 mm

NOUVEAUTÉ

455

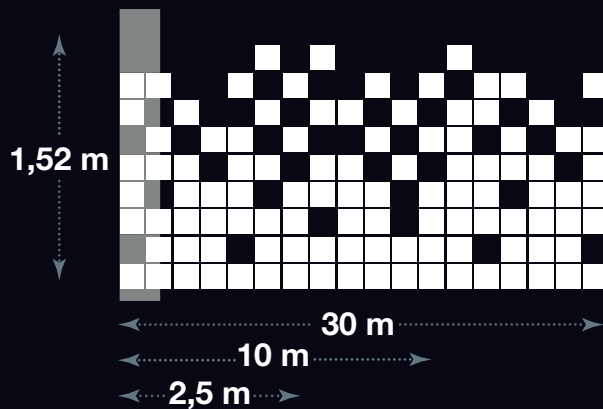

Carrés blanc de 45 mm
White squares of 45 mm

460

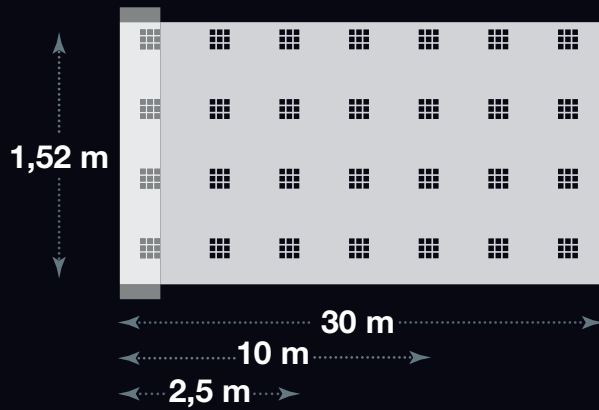
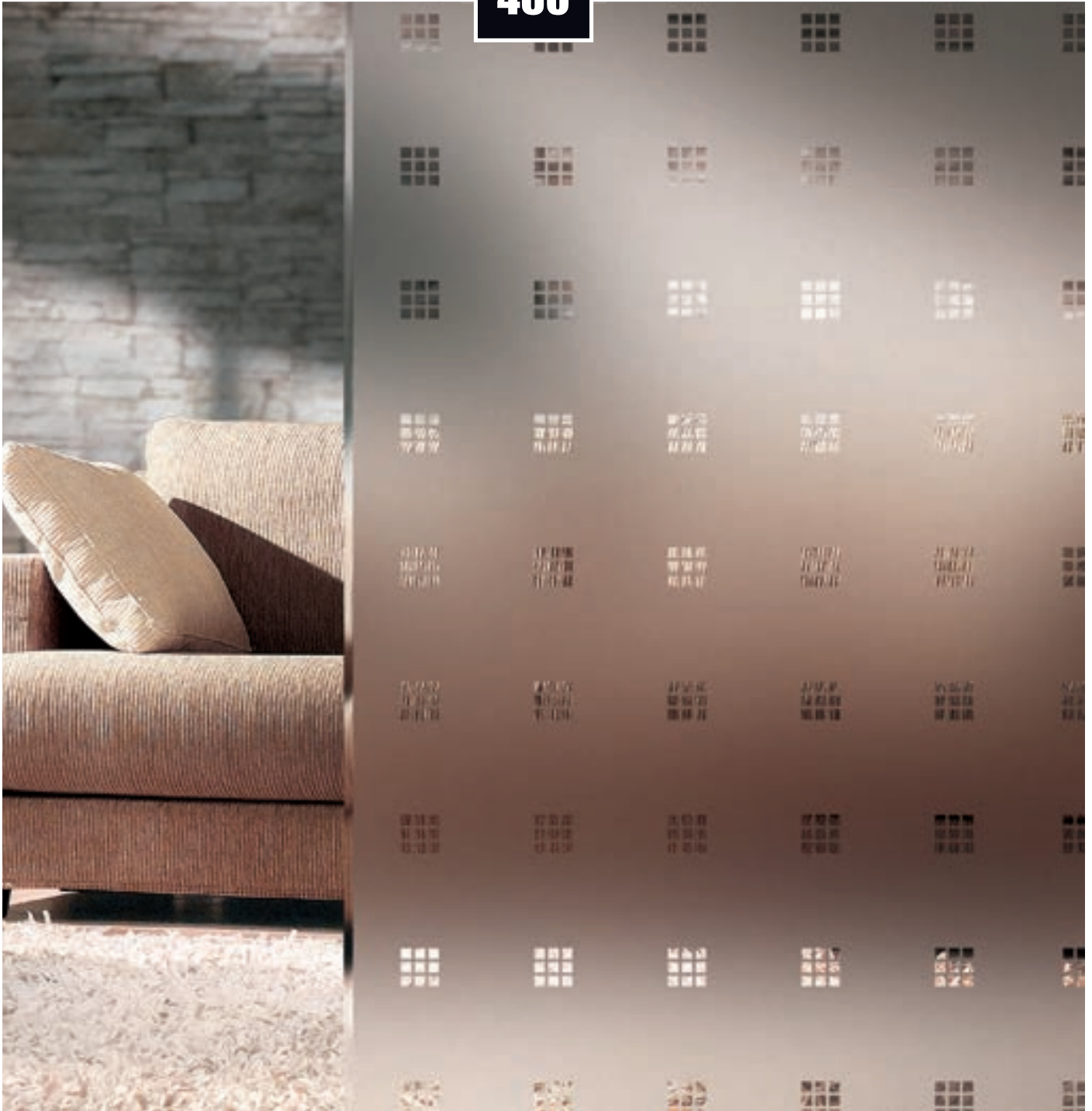

Carrés dépolis de 10 mm
Squares of 10 mm

468



1,52 m

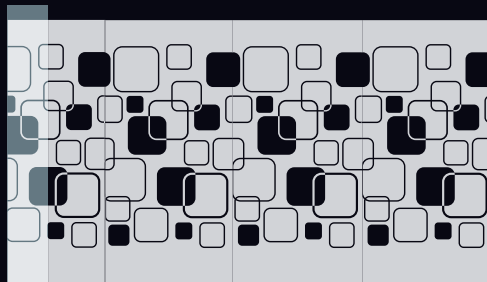

Carrés dépolis
Frosted squares

470

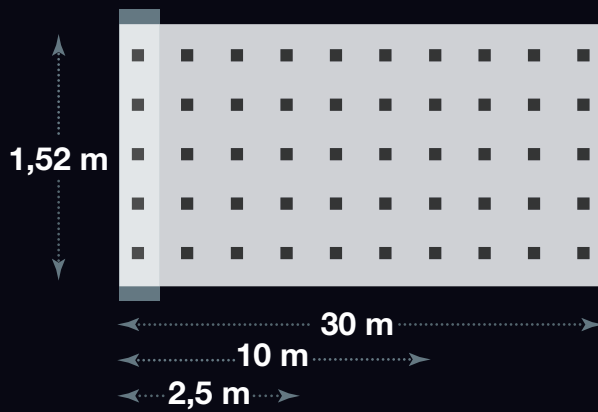
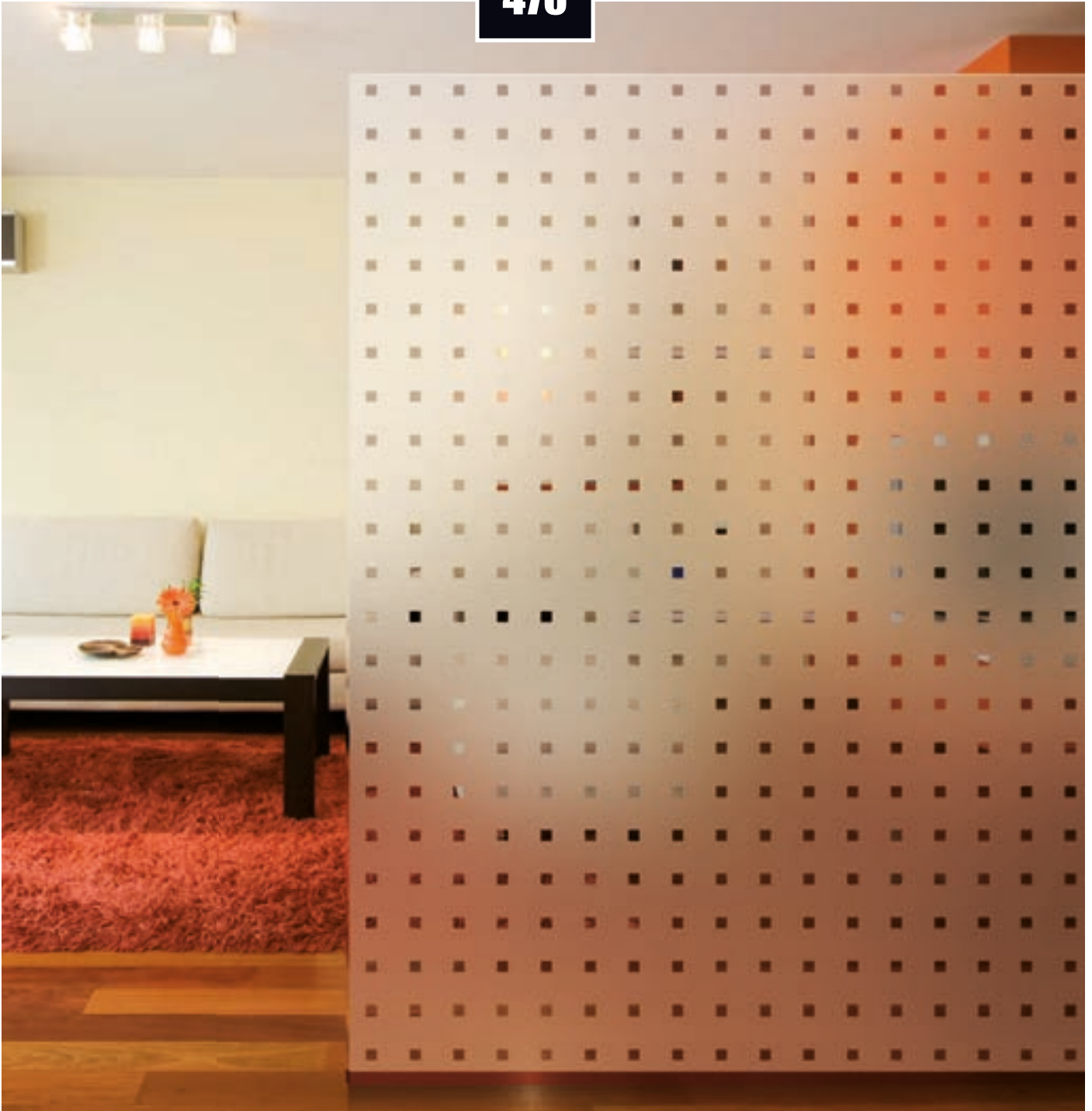

Dépoli à carrés transparents
Squares of 20 mm

480



1,52 m

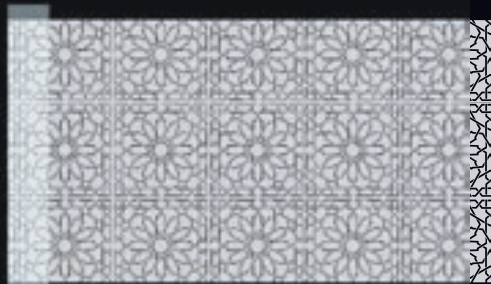

30 m
10 m
2,5 m

Rosaces dépolies
Frosted rosettes

490

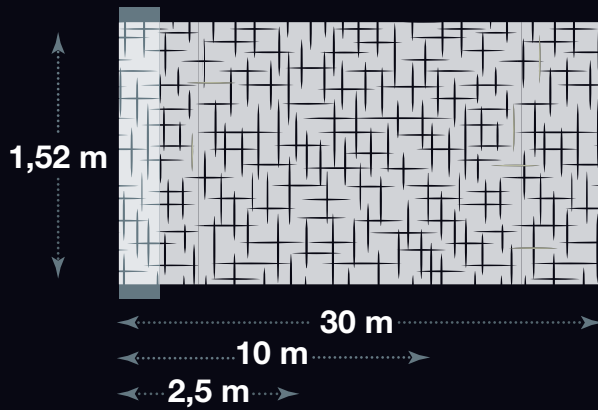

Dépoli à lignes croisées
Frosted crossed lines

500



1,52 m

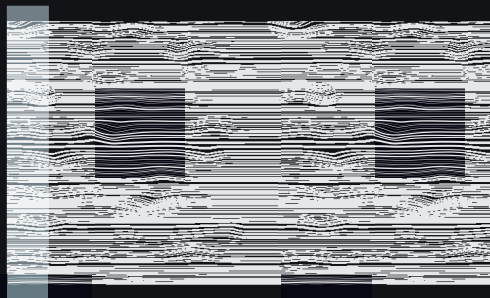

Traits blancs
White lines

30 m
10 m
2,5 m

510

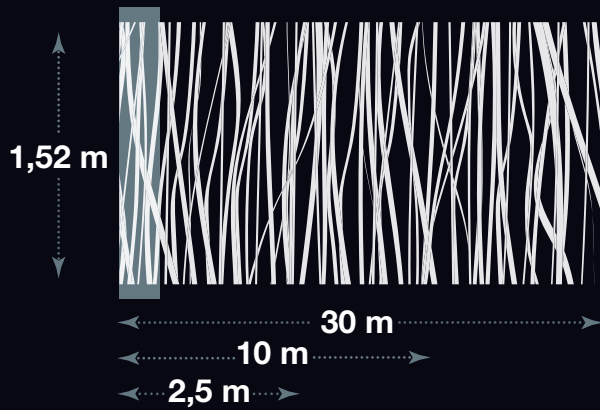

Courbes dépolies
Frosted thin curves

520

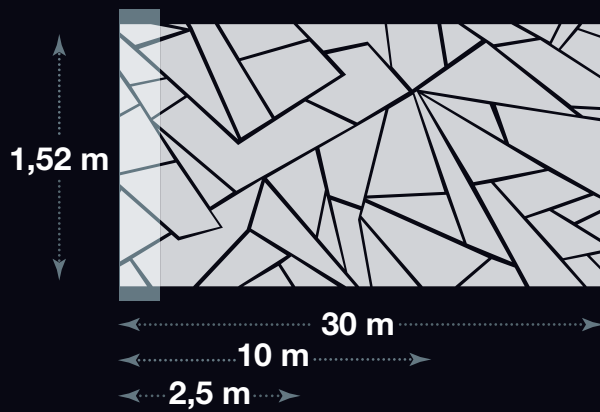
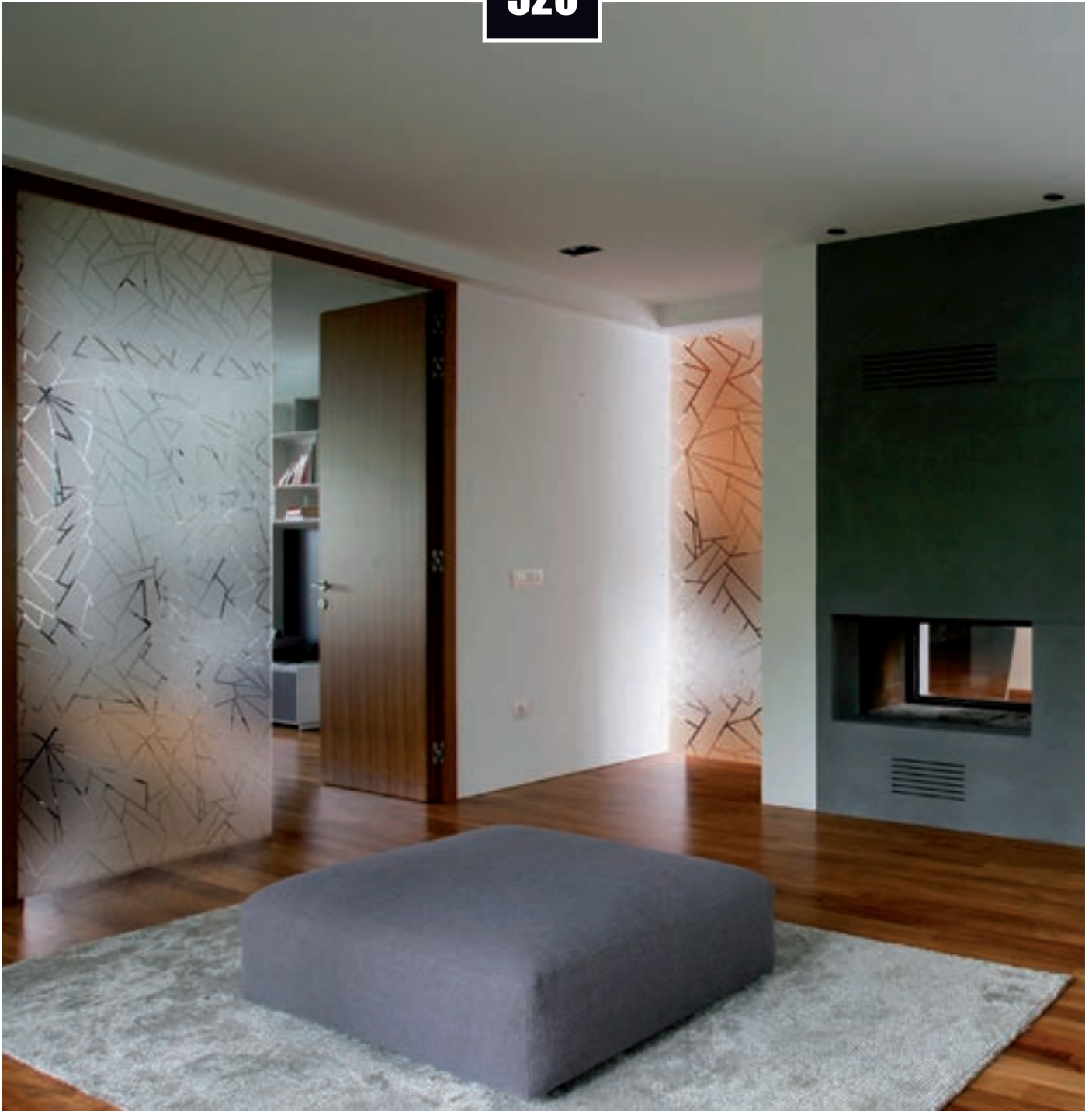

Dépoli effet verre brisé
Broken glass frosted

530

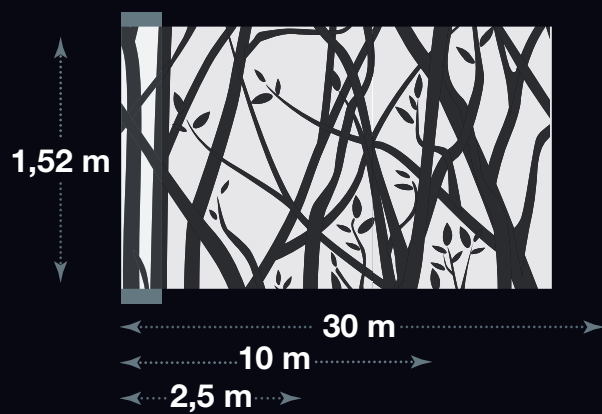
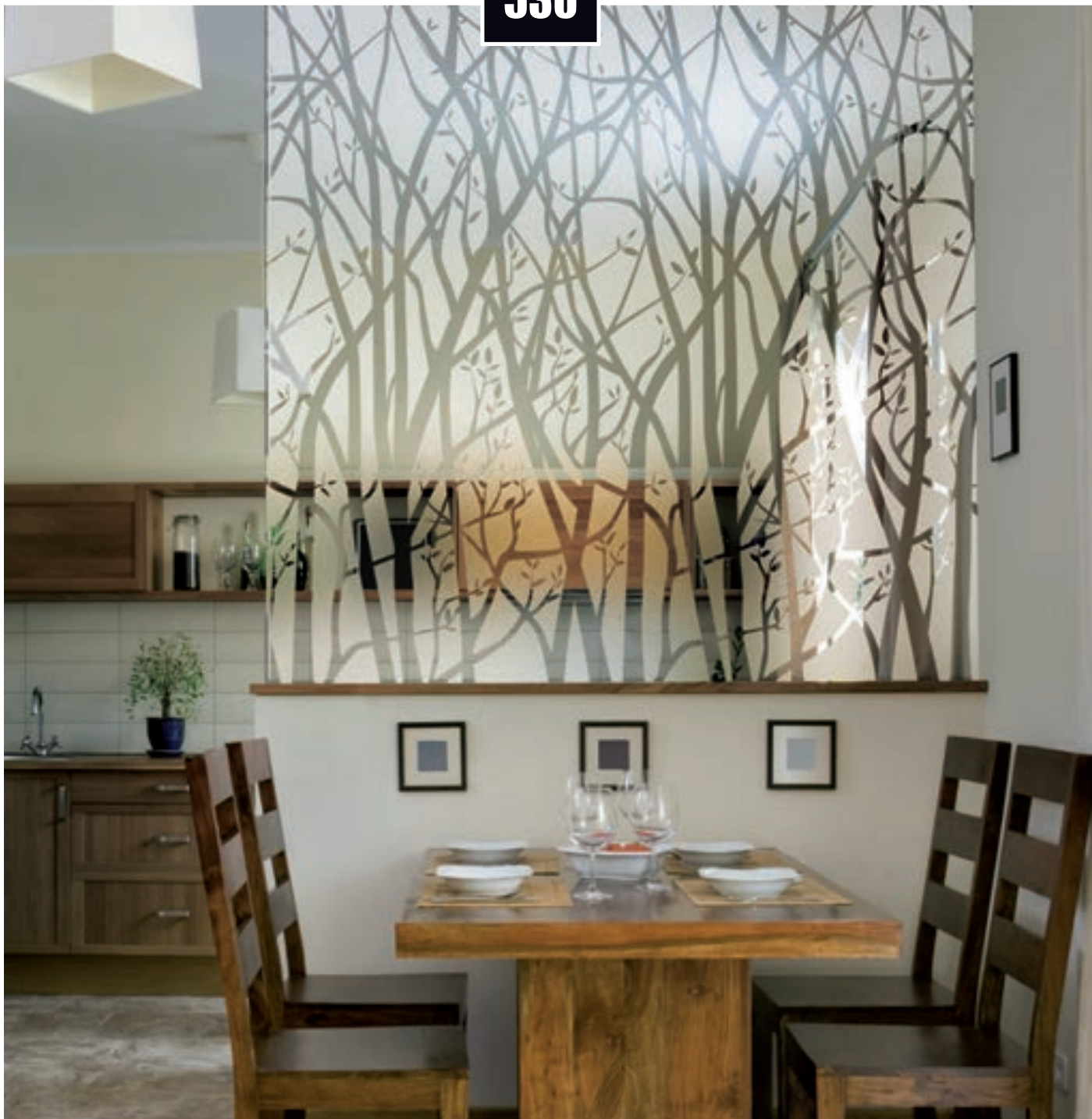

Arbres dépolis
Frosted trees

540

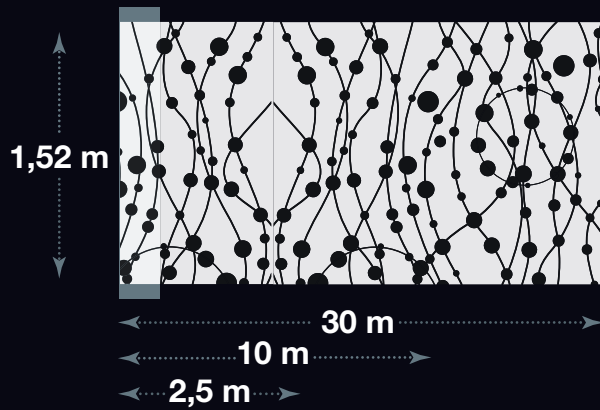
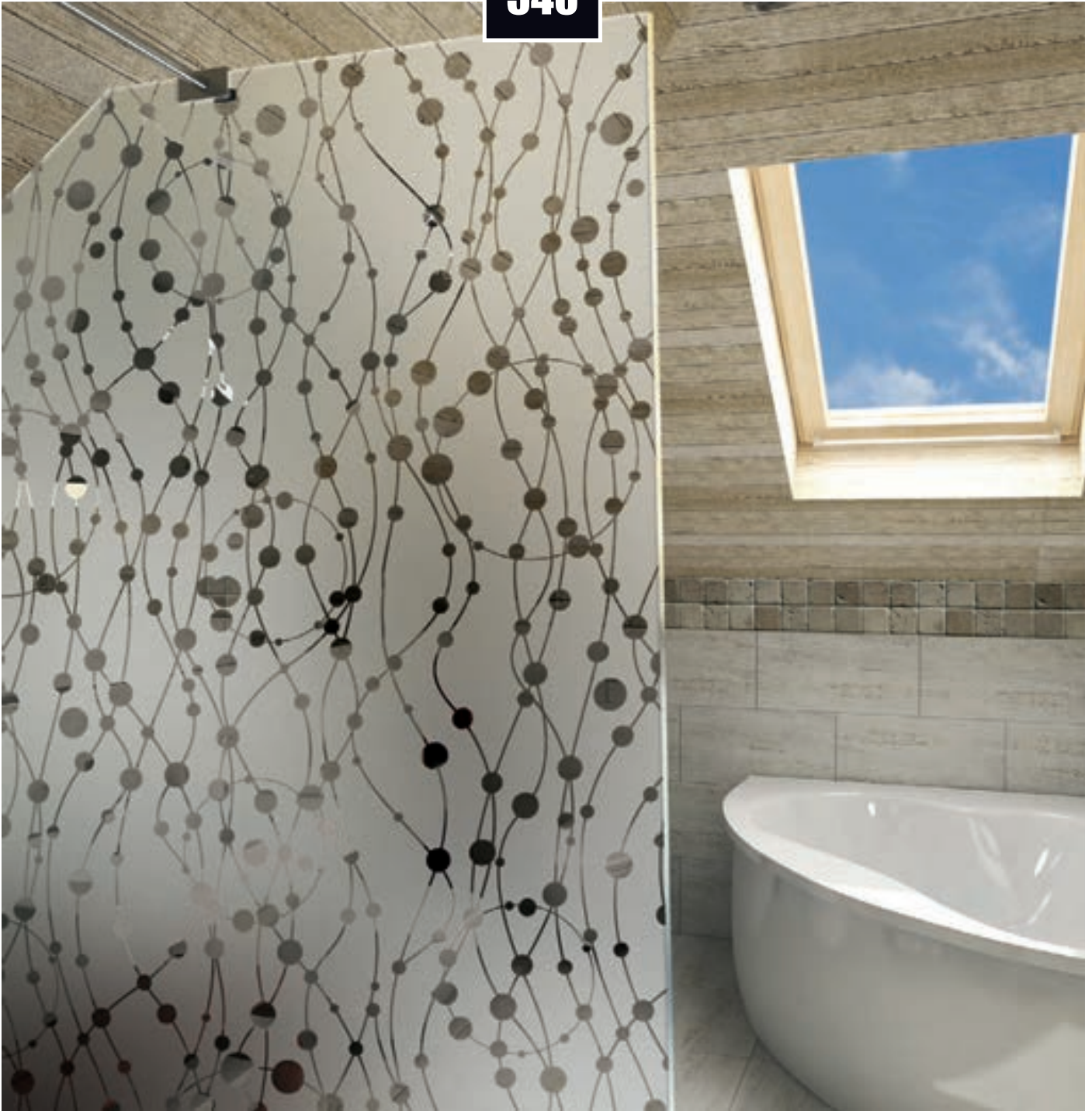

Dépoli à courbes et cercles
Frosted circles and curves

549

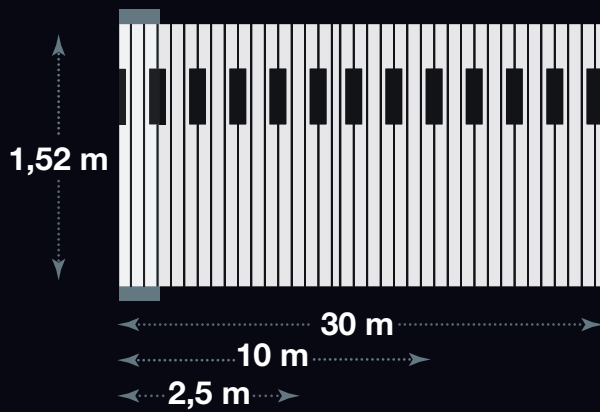
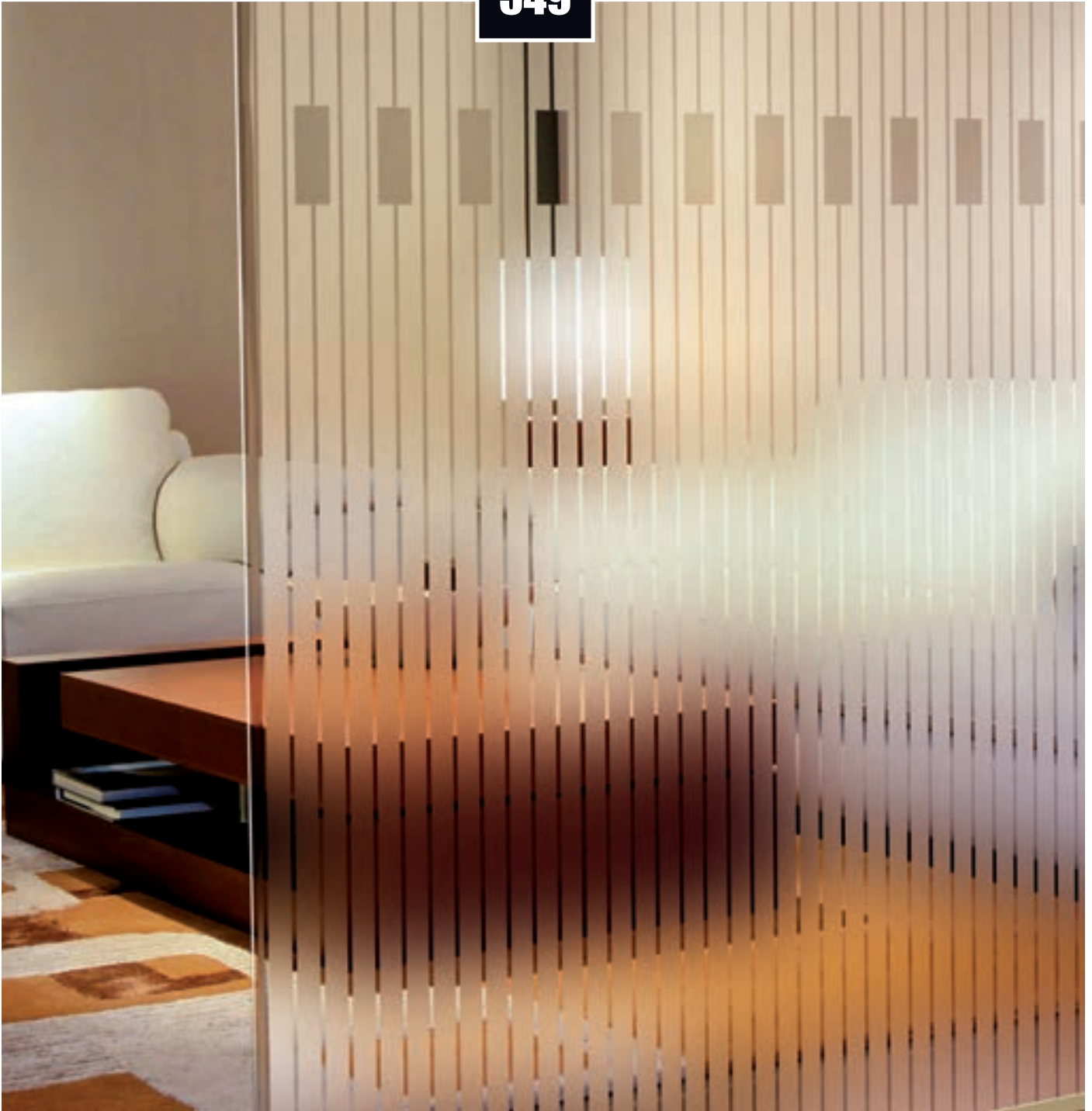

Bandes verticales dépolies
Frosted vertical stripes

560

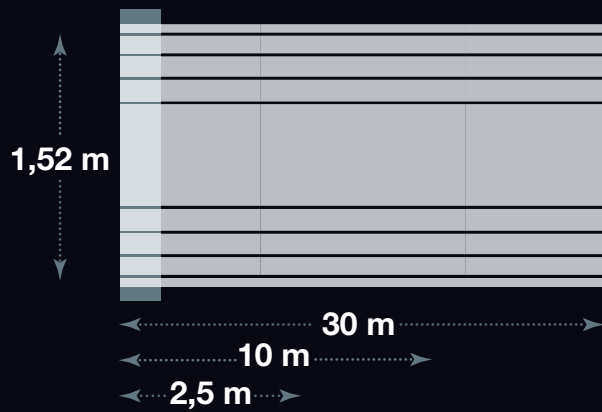

Bandes dépolies dégressives
Frosted decreasing stripes

606



1,52 m

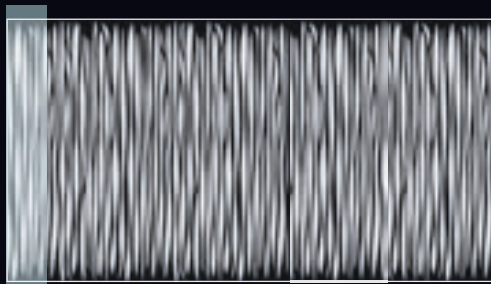

30 m
10 m
2,5 m

Courbes dépolies
Frosted thick curves

VTJ 310

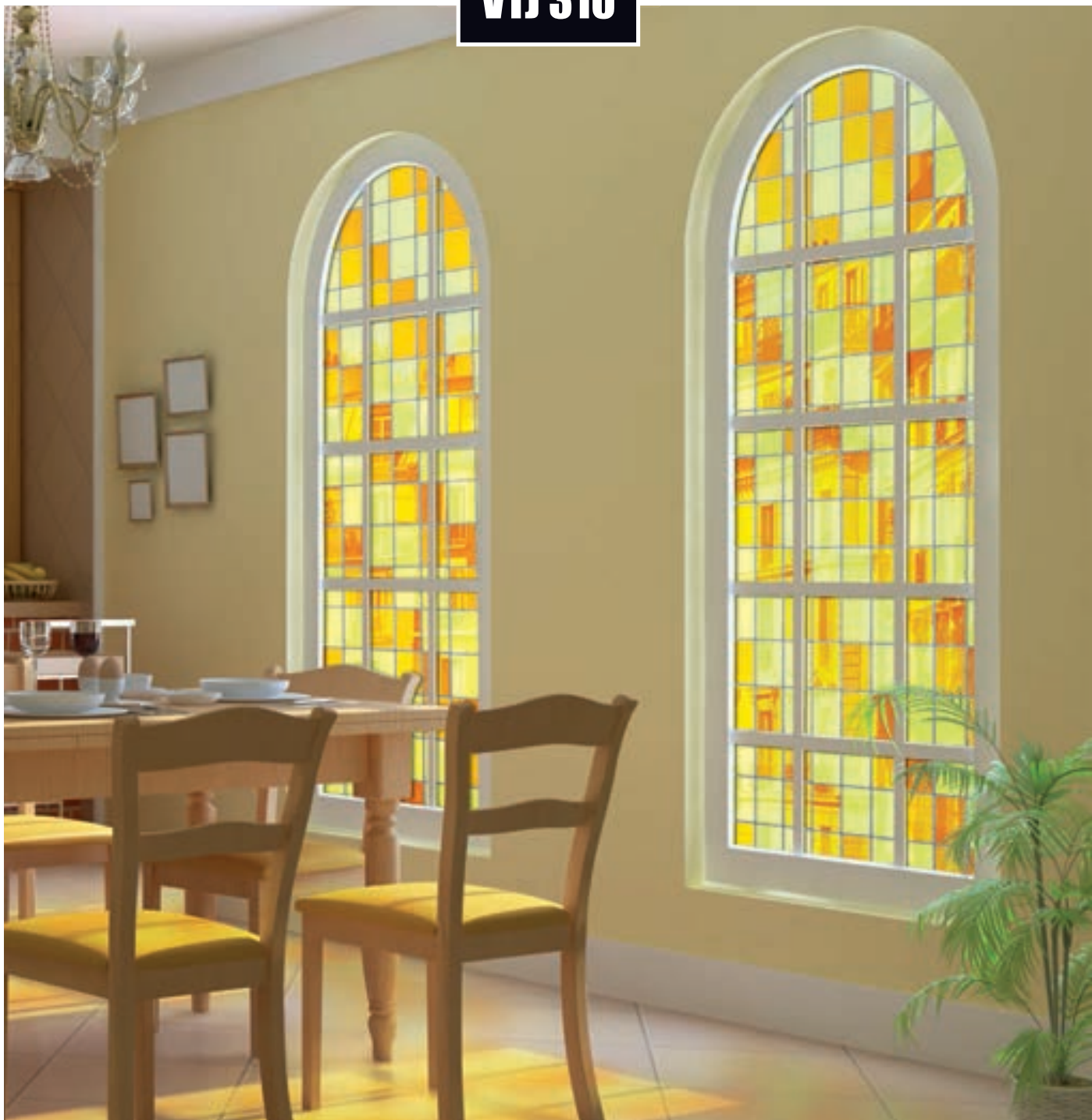

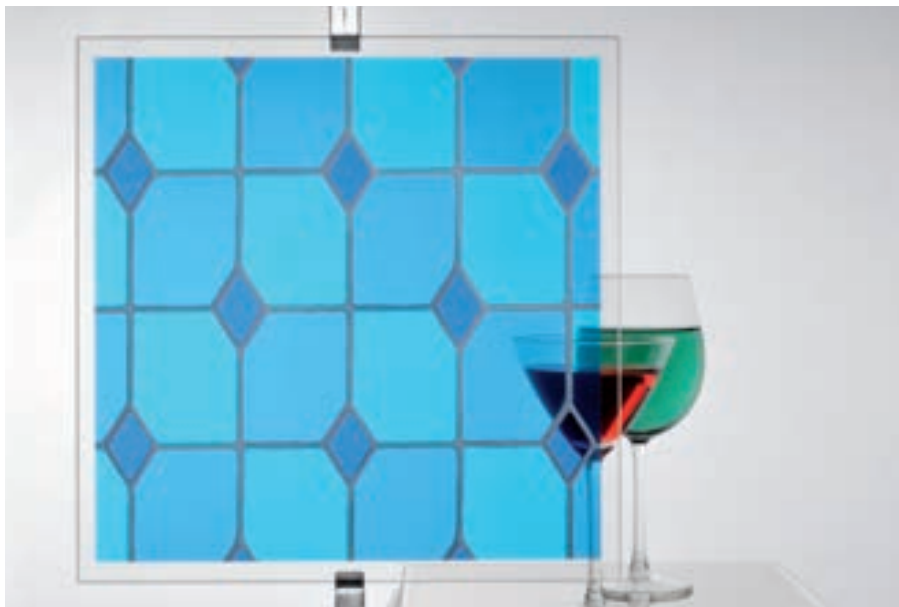

VTB 420



VTC 640



VTL 530

Couleurs



TEINTENT TOUS LES VITRAGES / TINT ALL GLAZINGS / COLOREAN TODOS LOS CRISTALES

Fuchsia

Prune

Noir

Bronze

Rose

Violet

Bleu océan

Bleu azur

Bleu turquoise

Vert menthe

Vert printemps

Jaune

Orange

Framboise

Rouge
Vermillon

Lila





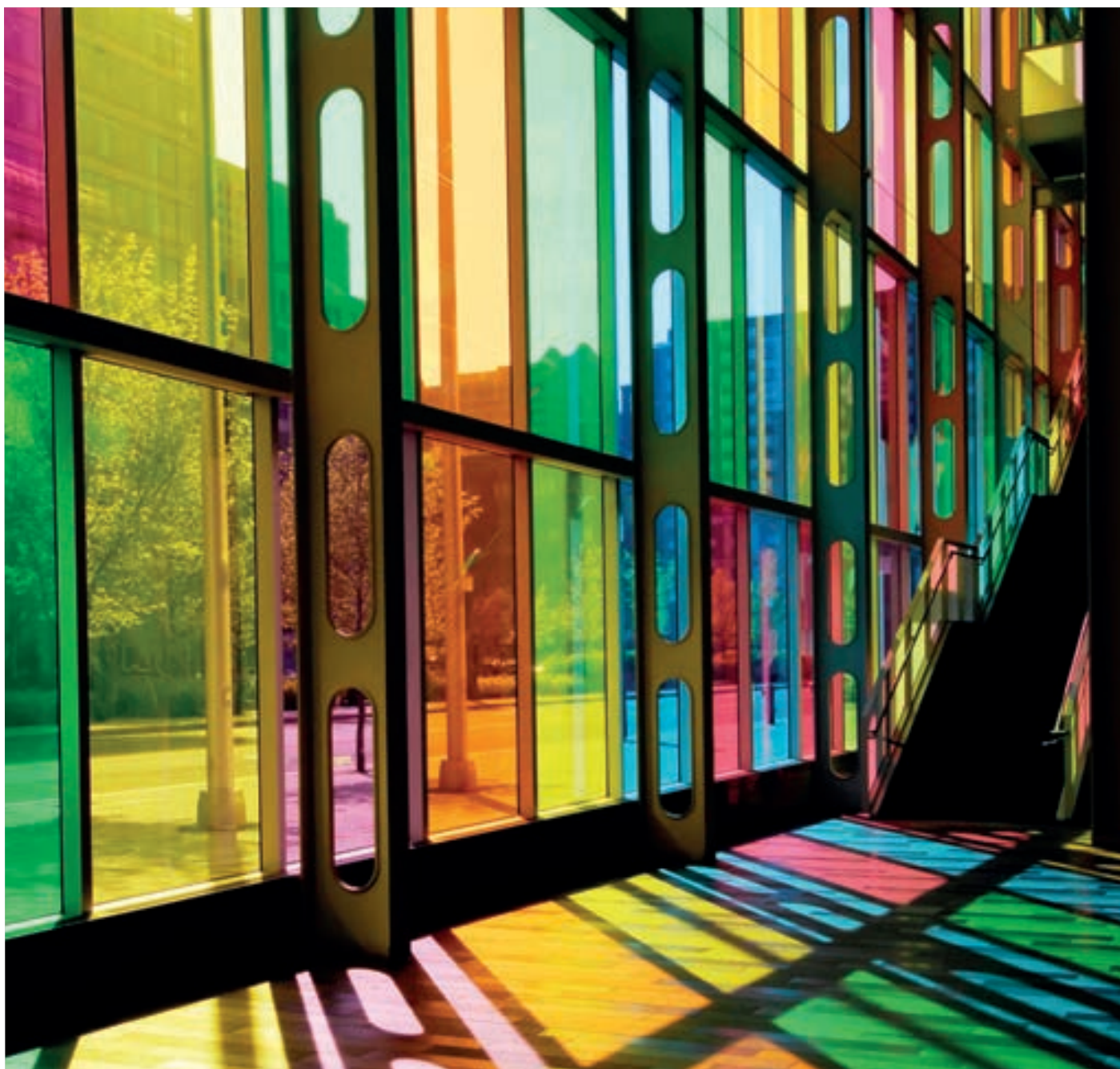

Grâce aux films de couleur, teintez tous types de vitrage : fenêtres, cloisons PVC, pare-douches, tables en verre, etc. Parfaitement transparents, ces films permettent d'apporter couleur et gaieté à vos vitrages tout en conservant la transparence du verre.

Thanks to these color films you can tint all types of glazing: windows, PVC partitions, shower screens, glass tables, etc. Perfectly transparent, these films can provide color and cheerfulness to your glass, whilst maintaining the transparency of the glass.

Gracias a estas láminas de colores puedes dar color a todo tipo de cristal : ventanales, particiones PVC, cristal de baños, duchas, mesas de cristal etc. Perfectamente transparentes, estas láminas pueden dar color y alegrar tus cristales manteniendo la transparencia del cristal.



Con le pellicole a colori, potete colorare tutti i tipi di vetri: finestre, pareti divisorie in PVC, box doccia, tavoli in vetro, ecc. Perfettamente trasparente, queste pellicole consentono di portare colore e allegria alle vostre finestre, pur mantenendo la trasparenza del vetro.

Dank diesen Farbfolien können Sie jegliche Arten von Verglasungen färben, z.B Fenster, PVC Wände, Duschabtrennungen, Glastische, usw.

Diese vollkommen durchsichtigen Folien bringen Farbe und Heiterkeit, ohne die Transparenz des Glases zu verringern.

