

System: Laufschiene mit Festglashalterung, Wand- oder Deckenmontage für 1 Glastüre bis 100kg.

System: Top track with fixed glass support profile, wall- or ceiling mounted, for 1 glass door up to 100kg.

Système: Rail de roulement avec porte-verre fixe, montage mural ou au plafond, pour 1 porte en verre jusqu'à 100kg.

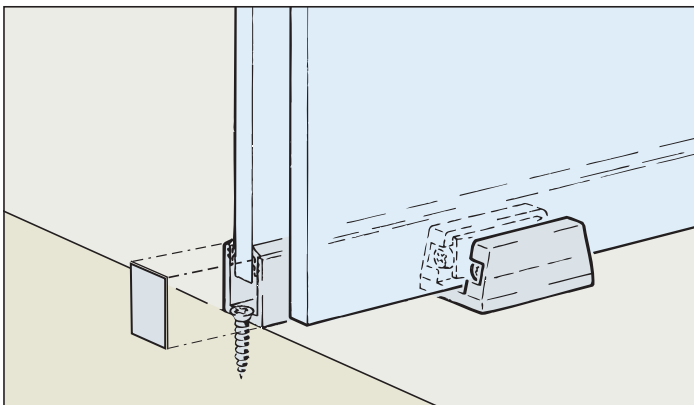

Einbaubeispiele / Mounting examples / Exemples de montage

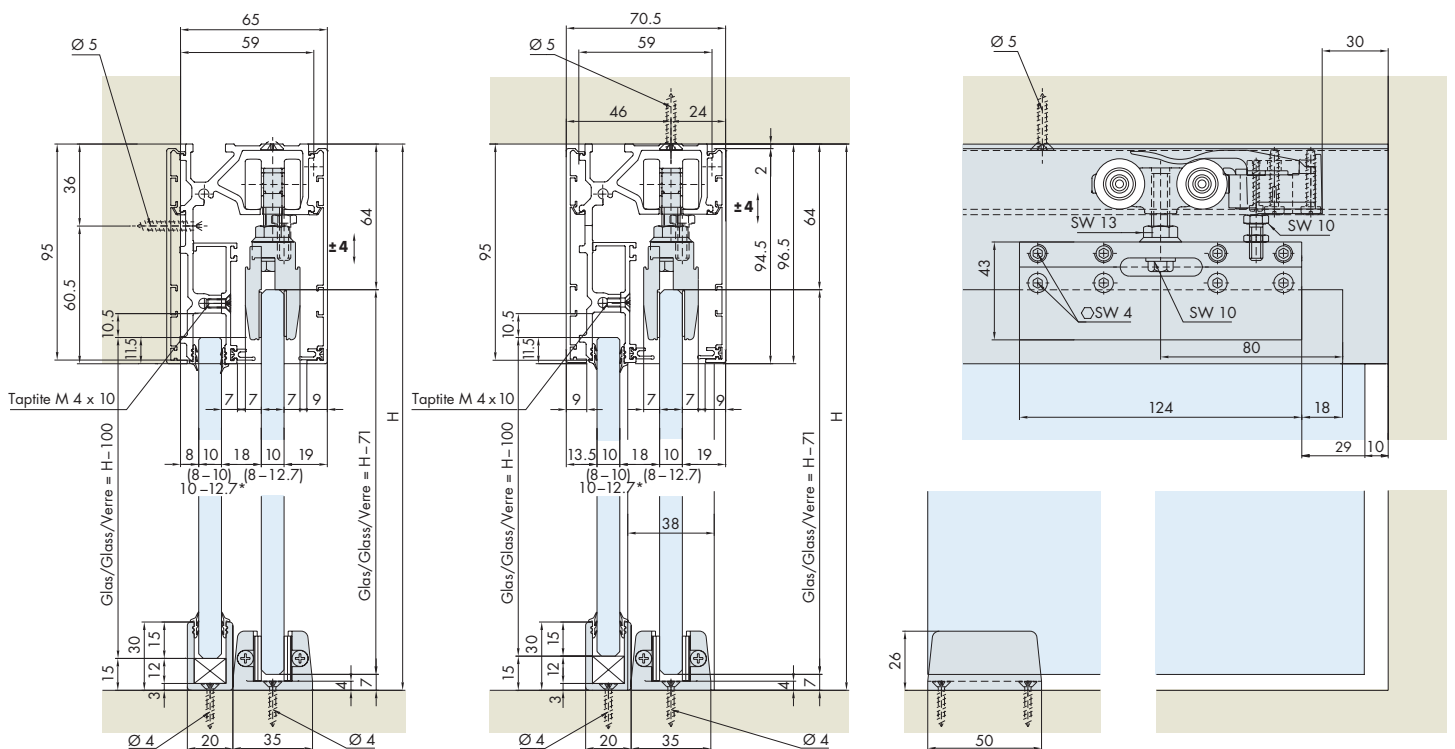

* 10-12.7 mm Glas, Nassversiegelung mit Silikon
 10-12.7 mm glass, wet caulking with silicone
 10-12.7 mm verre scellage au mouillé avec silicone
 Art. No. 098.0027.000 □ 36

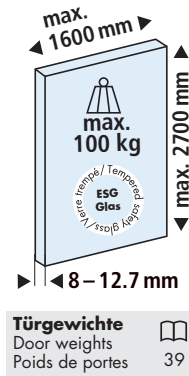
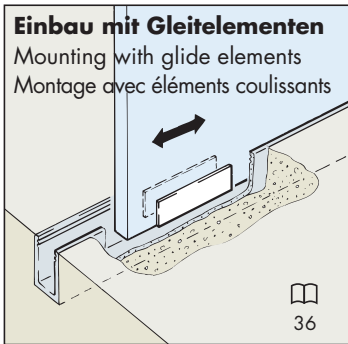

Garnituren / Sets / Garnitures

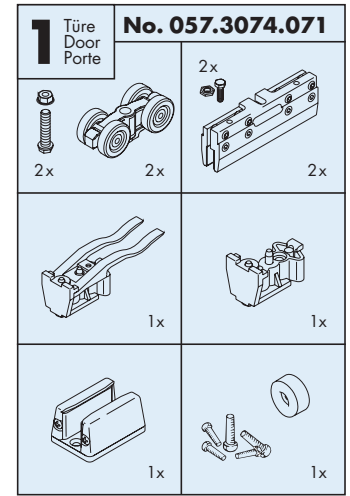

Zubehör / Accessories / Accessoires

Laufschiene Festglas, Alu gelocht

Running track fixed glass, aluminium pre-drilled
Rail de roulement vitre fixe, en alu perforé

Gr./Size	Art. No.
2500 mm	057.3053.250
3500 mm	057.3053.350
6000 mm	057.3053.600

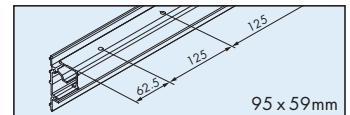

Festglashalteprofil, Alu eloxiert, gelocht

Fixed glass support profile, aluminium anodized, pre-drilled
Profil de retenue de porte-vitre fixe, en alu anodisé, perforé

2500 mm	057.3057.250
6000 mm	057.3057.600

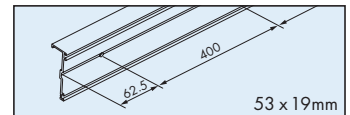

Befestigungs-Set zu 057.3056

Fixing set for 057.3056
Jeu de fixation pour 057.3056

057.3076.071

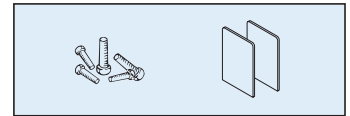

U-Führungsschiene, Alu eloxiert, gelocht

U-shaped guide track, aluminium anodized, pre-drilled
Rail de guidage U, en alu anodisé, perforé

2500 mm	057.3056.250
3500 mm	057.3056.350
6000 mm	057.3056.600

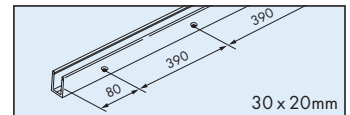

Clip-Blende zu Laufschiene, Alu eloxiert

Clip panel for running track, aluminium anodized
Cache à clipser pour rail de roulement, en alu anodisé

2500 mm	057.3050.250
3500 mm	057.3050.350
6000 mm	057.3050.600

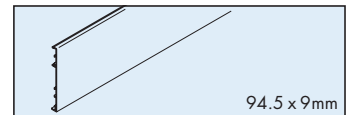

Blendenendstück-Set, Alu eloxiert, einseitig, Wandmontage

Panel end component set, aluminium anodized, one-sided, wall-mounting
Jeu d'extrémités de cache, en alu anodisé, un côté, montage mural

64.5 mm 057.3052.072

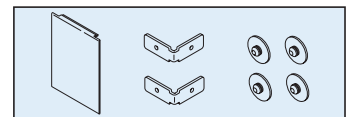

Blendenendstück-Set, Alu eloxiert, einseitig, Deckenmontage

Panel end component set, aluminium anodized, one-sided, ceiling-mounting
Jeu d'extrémités de cache, en alu anodisé, un côté, montage au plafond

70.5 mm 057.3052.073

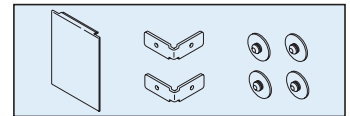

Dichtungsprofil, Kunststoff schwarz, in Rollen

Sealing profile, plastic black, in coils
Profil d'étanchéité, plastique noire, en rouleaux

20 m 057.3072.001

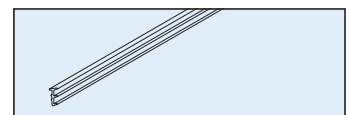

Sichtschutzdichtung, Kunststoff schwarz, in Rollen

Screening seal, plastic black, in coils
Joint pare-vue, plastique noir, en rouleaux

20 m 057.3078.002

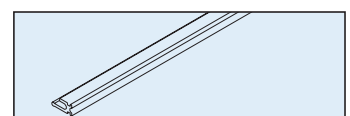

Sonderzubehör / Special accessories / Accessoires spéciaux: 36

Technische Daten / Technical data / Caractéristiques techniques: 39