

System: Laufschiene mit Festglashalterung, Einbauhöhe 58 mm, einsetzbar bei aufgesetzter oder deckenbündiger Anwendung, für 1 Glastüre bis 100 kg.

System: Running track with fixed glass support profile, installation height 58 mm, surface mounted or flush with the ceiling, for 1 glass door up to 100 kg.

Système: Rail de roulement avec porte-vitre fixe, hauteur d'installation 58 mm, montage en applique ou affleurant avec le plafond, pour 1 porte en verre jusqu'à 100 kg.

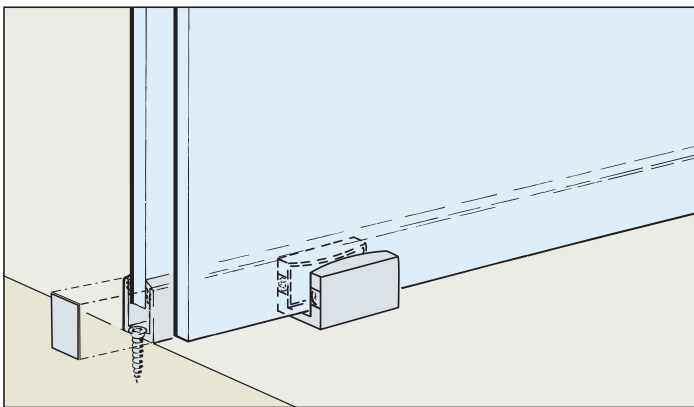

Einbaubeispiele / Mounting examples / Exemples de montage

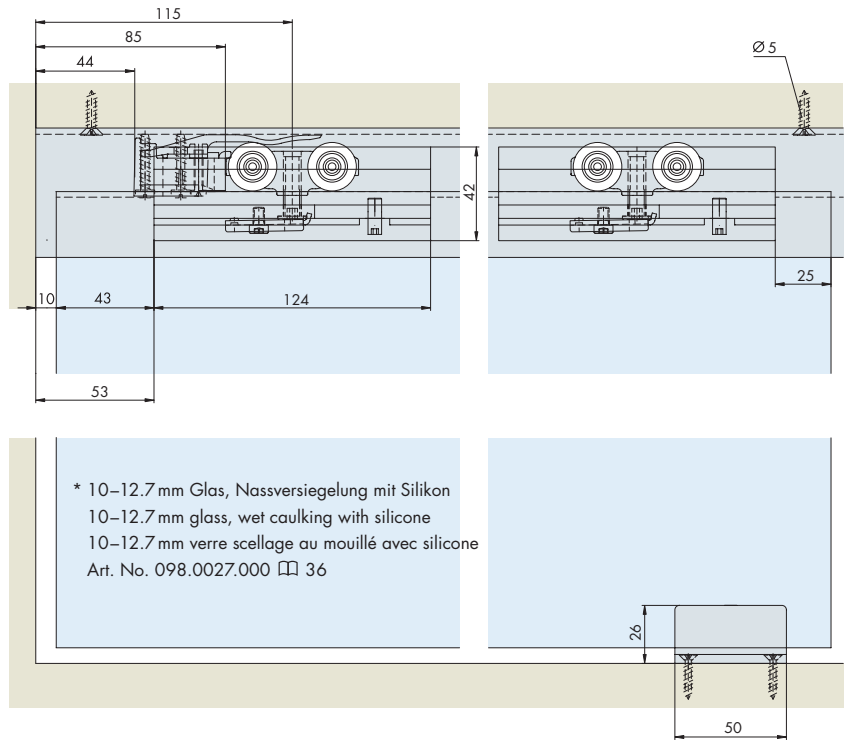
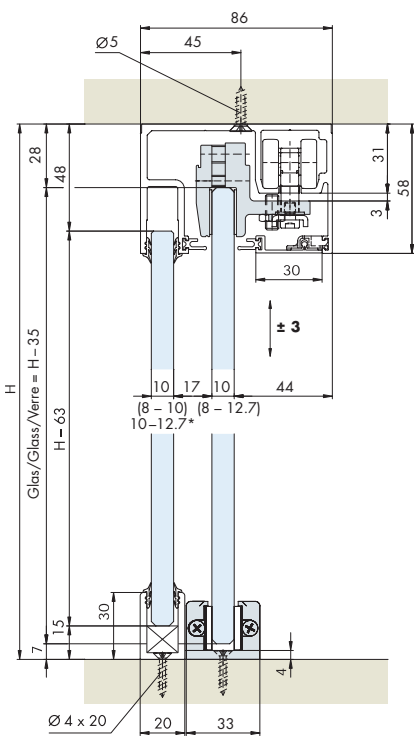

Einbaubeispiel deckenbündig

Mounting example flush with the ceiling

Exemple de montage affleurant avec le plafond

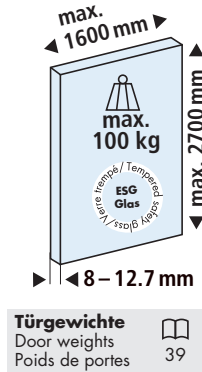
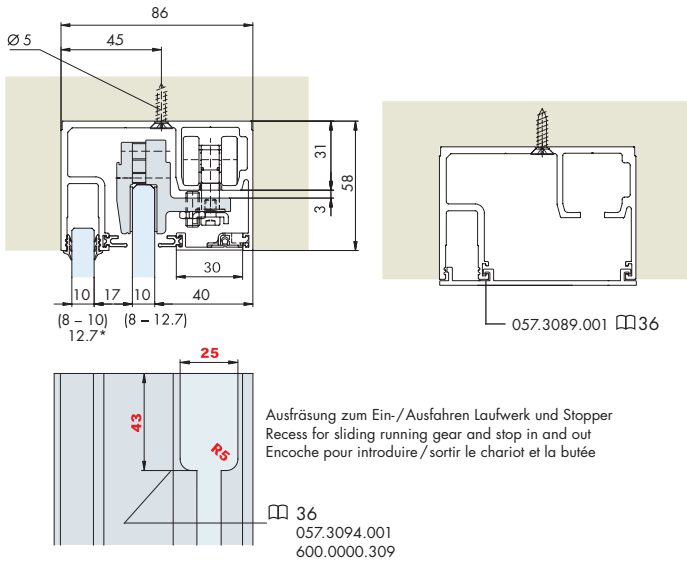

Garnituren / Sets / Garnitures

1		Türe Door Porte		No. 057.3091.071	
2x		2x		2x	
1x		1x		1x	
1x		12x		1x	
1x		1x		1x	

Zubehör / Accessories / Accessoires

Laufschiene Festglas, Alu eloxiert, gelocht

Running track fixed glass, aluminium anodized, pre-drilled
Rail de roulement vitre fixe, en alu anodisé, perforé

Gr./Size	Art. No.
2500 mm	057.3084.250
3500 mm	057.3084.350
6000 mm	057.3084.600

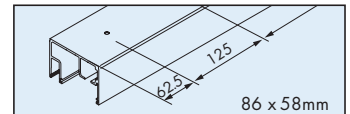

Blendenprofil, Alu eloxiert

Panel profile, aluminium anodized
Profil de cache, en alu anodisé

Gr./Size	Art. No.
2500 mm	057.3085.250
3500 mm	057.3085.350
6000 mm	057.3085.600



Stirnprofil, Alu eloxiert, zu 057.3084

Front edge profile, aluminium anodized, for 057.3084
Profil à l'avant, en alu anodisé, pour 057.3084

Gr./Size	Art. No.
2500 mm	042.3005.250
3000 mm	042.3005.300
6000 mm	042.3005.600



U-Führungsschiene, Alu eloxiert, gelocht

U-shaped guide track, aluminium anodized, pre-drilled
Rail de guidage en U, en alu anodisé, perforé

Gr./Size	Art. No.
2500 mm	057.3056.250
3500 mm	057.3056.350
6000 mm	057.3056.600

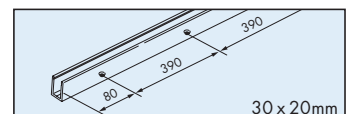

Befestigungs-Set zu 057.3056

Fixing set for 057.3056
Jeu de fixation pour 057.3056

057.3076.071

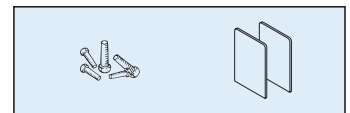

Dichtungsprofil, Kunststoff schwarz, in Rollen

Sealing profile, plastic black, in coils
Profil d'étanchéité, plastique noir, en rouleaux

20 m 057.3072.001

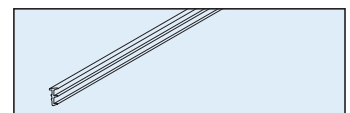

Sichtschutzdichtung, Kunststoff schwarz, in Rollen

Screening seal, plastic black, in coils
Joint pare-vue, plastique noir, en rouleaux

20 m 057.3078.002

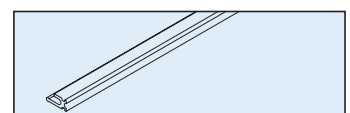

Schienebearbeitung = rote Zahlen / Dimensions and drillings for profile = red numbers / Traitement de profil = chiffres rouges

Sonderzubehör / Special accessories / Accessoires spéciaux: 36

Technische Daten / Technical data / Caractéristiques techniques: 39