

Art.-Nr. 04.5000

Wasserabweiser, Acryl transparent, für 8 mm Glas.

Gewicht: 0,106 kg/m

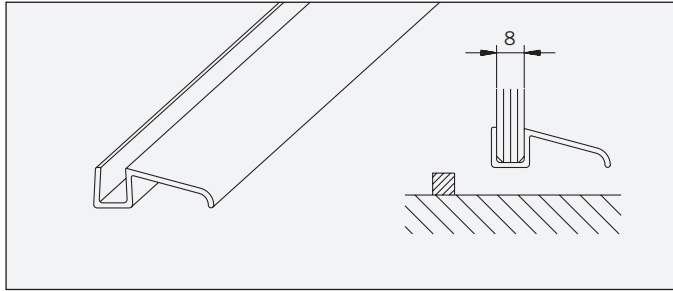

Art.-No. 04.5000

Water disperser, transparent acrylic, for 8 mm glass.

Weight: 0,106 kg/m

Art.-Nr. 04.5040

Wasserabweiser, Acryl transparent, mit weicher Lippe, für 8 mm Glas.
L: 2000 mm

Gewicht: 0,119 kg/m

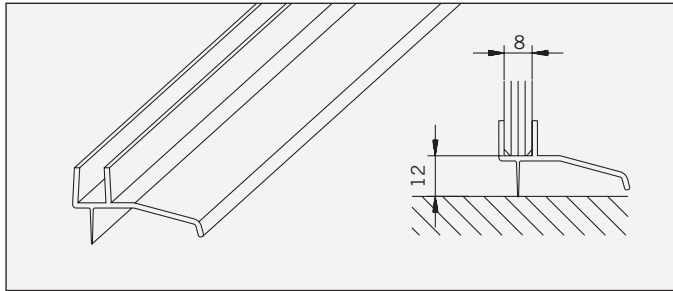

Art.-No. 04.5040

Water disperser, transparent acrylic, with soft lip, for 8 mm glass.
L:2000 mm

Weight: 0,119 kg/m

Art. Nr. 04.5042

Wasserabweiser, Acryl transparent, mit weicher Lippe für 8-10 mm Glas.

Gewicht: 0,10 kg/m

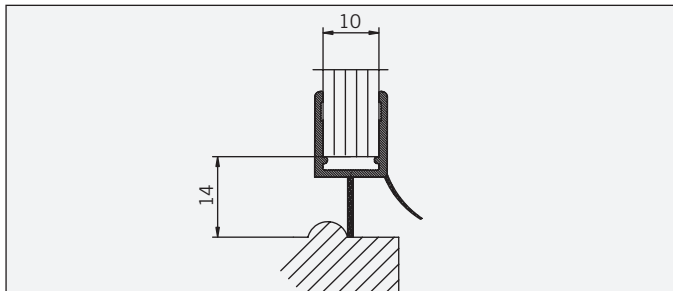

Art.-No. 04.5042

Water disperser, transparent acrylic, with soft lip for 8-10 mm glass.

Weight: 0,10 kg/m

Art.-Nr. 04.5044

Wasserabweiser, Acryl transparent, für 6 und 8 mm Glas.
L: 2000 mm

Gewicht: 0,127 kg/m

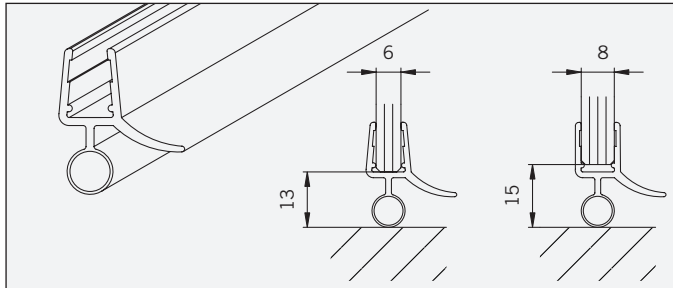

Art.-No. 04.5044

Water disperser, transparent acrylic, for 6 and 8 mm glass, 2000 mm long

Weight: 0,127 kg/m

Art.-Nr. 04.5046

Wasserabweiser, Acryl transparent, mit feinem Vollrundprofil und kurzem Glaseinstand für 8 mm Glas.
L: 2000 mm

Gewicht: 0,120 kg/m

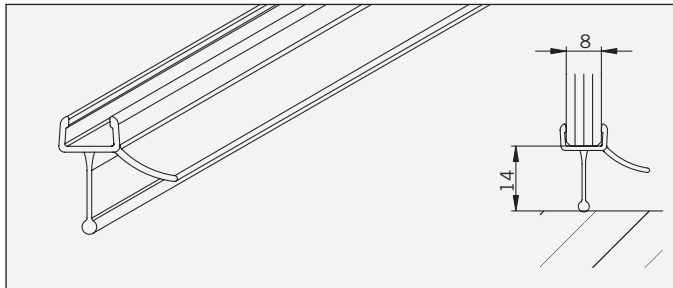

Art.-No. 04.5046

Water disperser, transparent acrylic, with slim solid washer and short glass channel for 8 mm glass.
L: 2000 mm

Weight: 0,120 kg/m

Art. Nr. 04.5047

Wasserabweiser, Acryl transparent, mit feinem Vollrundprofil und kurzem Glaseinstand für 6 mm Glas.
L: 2000 mm

Gewicht: 0,120 kg/m

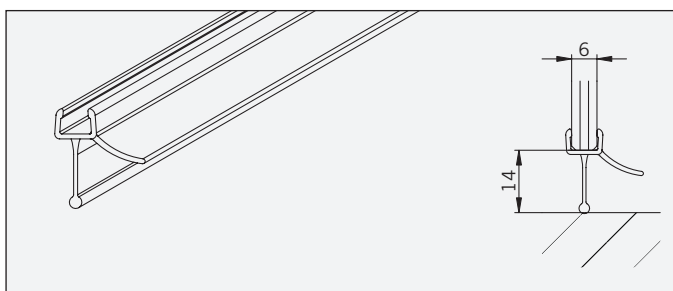

Art.-No. 04.5047

Water disperser, transparent acrylic, with slim solid washer and short glass channel for 6 mm glass.
L: 2000 mm

Weight: 0,120 kg/m

Art. Nr. 04.5049

Wasserabweiser gebogen für
Duschtypen 150 und 252, mit
feinem Vollrundprofil und kurzem
Glaseinstand, für 6 mm Glas.

Gewicht: 0,120 kg/m



Art.-No. 04.5049

Water disperser, bent for shower
types 150 and 252, with slim
solid washer and short glass
channel for 6mm glass.

Weight: 0,120 kg/m

Art.-Nr. 04.5050

Unteres o. seitliches Dichtprofil,
Acryl transparent, mit weicher
Lippe, für 8 mm Glas.

L: 2000 mm

Art.-Nr. 04.5051

L: 2500 mm

Gewicht: 0,074 kg/m

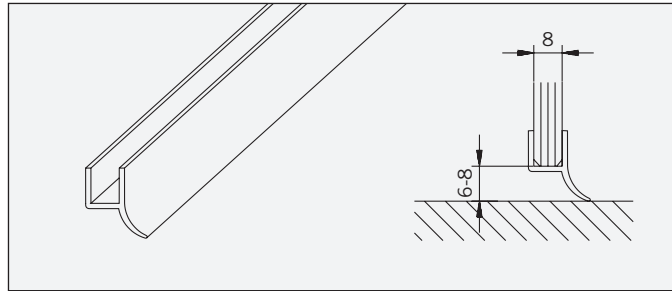

Art.-No. 04.5050

Bottom or lateral sealing profile,
transparent acrylic, with soft lip,
for 8 mm glass.

L: 2000 mm

Art.-No. 04.5051

L: 2500 mm

Weight: 0,074 kg/m

Art.-Nr. 04.5070

Höhenausgleichprofil,
Acryl transparent,
für 8 mm Glas.

Gewicht: 0,134 kg/m

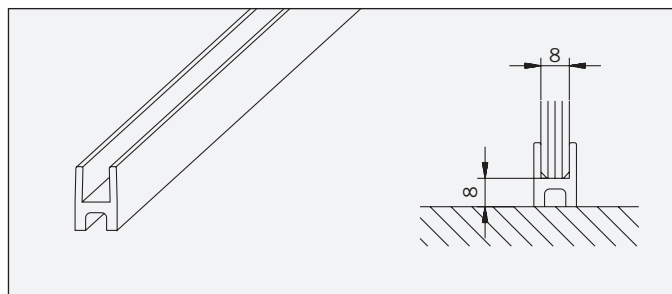

Art.-No. 04.5070

Height compensation
profile, transparent acrylic,
for 8 mm glass.

Weight: 0,134 kg/m

Art.-Nr. 04.5090

Anschlagdichtung 180°, acryl
transparent, mit weicher Lippe,
für 8 mm Glas.

L: 2000mm

Art.-Nr. 04.5091

L: 2500 mm

Gewicht: 0,076 kg/m

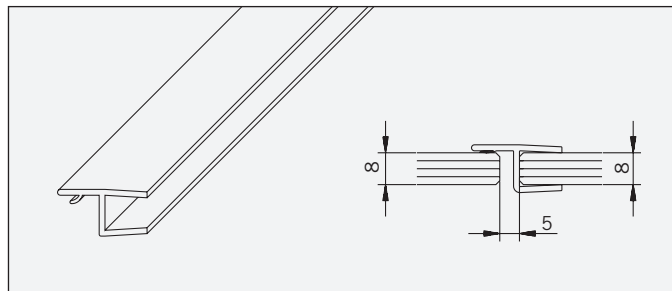

Art.-No. 04.5090

Rebate seal 180°, transparent
acrylic, with soft lip,
for 8 mm glass.

L: 2000 mm

Art.-No. 04.5091

L: 2500 mm

Weight: 0,076 kg/m

Art.-Nr. 04.5092

Schlauchdichtung, Acryl
transparent mit kurzem
Glaseinstand, für 8 mm Glas.

L: 2000 mm

Art.-Nr. 04.5093

L: 2500 mm

Gewicht: 0,080 kg/m

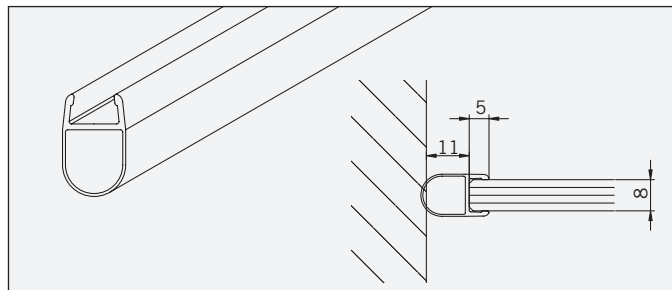

Art.-No. 04.5092

Soft nose seal, transparent acrylic
with short glass channel,
for 8 mm glass.

L: 2000 mm

Art.-No. 04.5093

L: 2500 mm

Weight: 0,080 kg/m

Art.-Nr. 04.5094

Schlauchdichtung, Acryl
transparent mit kurzem
Glaseinstand, für 6 mm Glas.

L: 2000 mm

Art.-Nr. 04.5095

L: 2500 mm

Gewicht: 0,080 kg/m

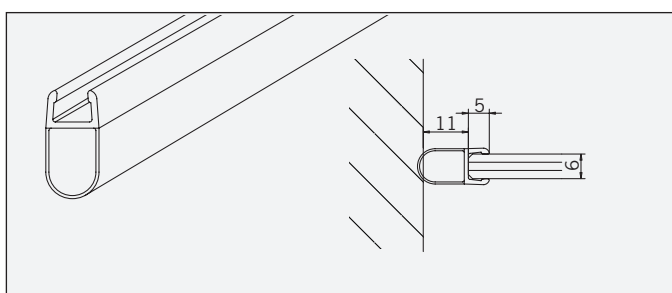

Art.-No. 04.5094

Soft nose seal, transparent acrylic
with short glass channel,
for 6 mm glass.

L: 2000 mm

Art.-No. 04.5095

L: 2500 mm

Weight: 0,080 kg/m

Art.-Nr. 04.5110

Anschlagdichtung 90°, Acryl transparent, mit weicher Lippe, für 8 mm Glas.

L: 2000 mm

Art.-Nr. 04.5111

L: 2500mm

Gewicht: 0,075 kg/m

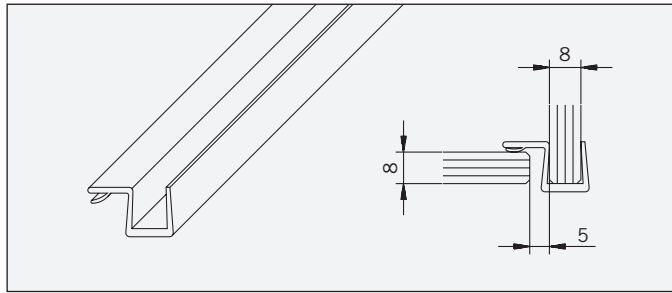

Art.-No. 04.5110

Rebate seal 90°, transparent acrylic, with soft lip, for 8 mm glass.

L: 2000mm

Art.-No. 04.5111

L: 2500mm

Weight: 0,075 kg/m

Art.-Nr. 04.5130

Mitteldichtung 180°, Acryl transparent, für 6 mm Glas.

L: 2000 mm

Art.-Nr. 04.5131

L: 2500 mm

Gewicht: 0,032 kg/m

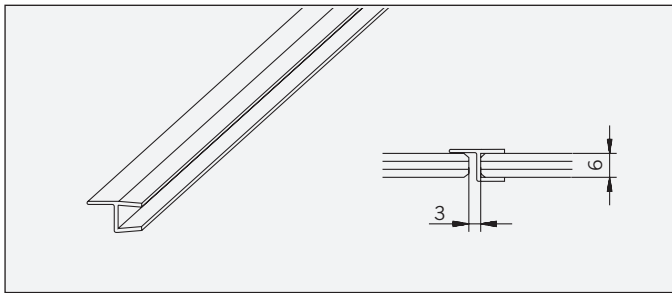

Art.-No. 04.5130

Middle seal 180°, transparent acrylic, for 6 mm glass.

L: 2000 mm

Art.-No. 04.5131

L: 2500 mm

Weight: 0,032 kg/m

Art.-Nr. 04.5140

Mitteldichtung 135°, Acryl transparent, für 8 mm Glas, für Fünfeckkabinen oder als Wandsichtung verwendbar.

L: 2000 mm

Art.-Nr. 04.5141

L: 2500 mm

Gewicht: 0,066 kg/m

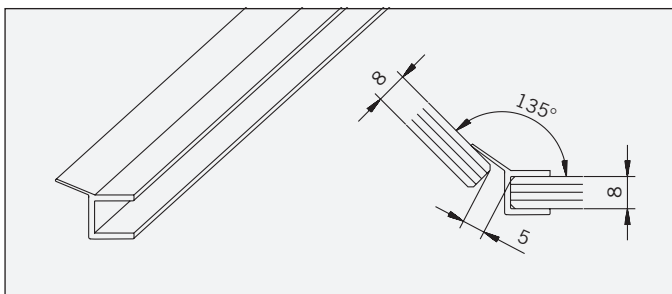

Art.-No. 04.5140

Middle seal 135°, transparent acrylic, for 8 mm glass, for pentagonal showers or can be used as wall seal.

L: 2000 mm

Art.-No. 04.5141

L: 2500 mm

Weight: 0,066 kg/m

Art.-Nr. 04.5170

Wandsichtung, Acryl transparent, mit weicher Lippe, für 6-8 mm Glas.

L: 2000 mm

Art.-Nr. 04.5171

L: 2500 mm

Gewicht: 0,078 kg/m

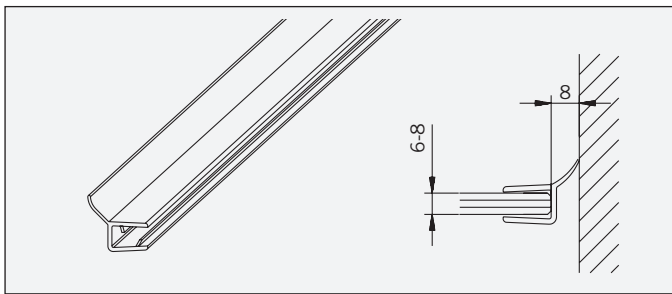

Art.-No. 04.5170

Wall seal, transparent acrylic, with soft lip, for 6-8 mm glass.

L: 2000 mm

Art.-No. 04.5171

L: 2500 mm

Weight: 0,078 kg/m

Art.-Nr. 04.5180

U-Ausgleichprofil, Acryl transparent, für 6 mm Glas.

Gewicht: 0,031 kg/m

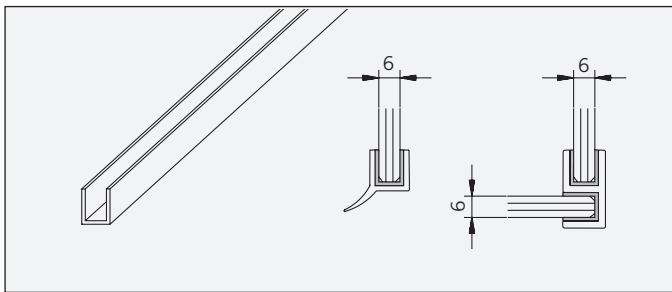

Art.-No. 04.5180

U-compensation profile, transparent acrylic, for 6 mm glass.

Weight: 0,031 kg/m

Art.-Nr. 04.5200

Anschlagdichtung, PVC weich, für Aluminiumprofile 04.0150, 04.0151, 04.0520 und 04.2050.

Gewicht: 0,016 kg/m

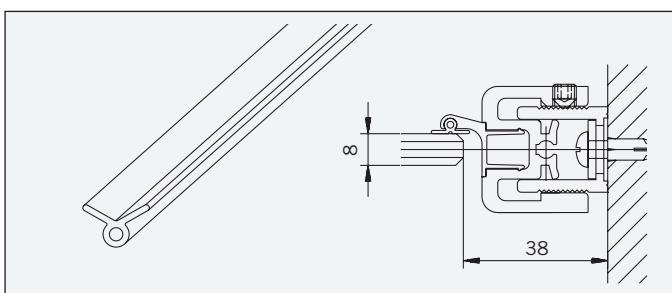

Art.-No. 04.5200

Rebate seal, PVC soft, for aluminium profiles 04.0150, 04.0151, 04.0520 and 04.2050.

Weight: 0,016 kg/m

Art.-Nr. 04.5210

Gummi-hohldichtung, PVC weich, für Aluminiumprofil 04.0230.

Gewicht: 0,029 kg/m

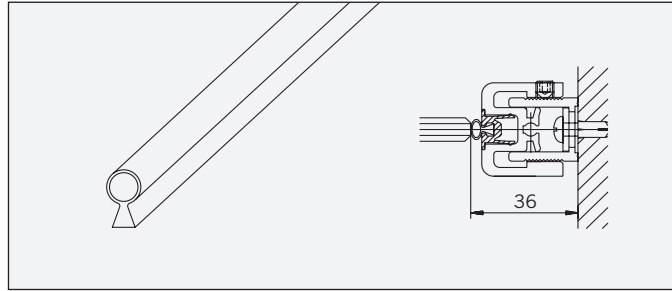

Art.-No. 04.5210

Hollow rubber profile, PVC soft, for aluminium profile 04.0230.

Weight: 0,029 kg/m

Art.-Nr. 04.5220

Eck-Verbindungsprofil 90°, Acryl transparent, für 8 mm Glas.

Gewicht: 0,130 kg/m

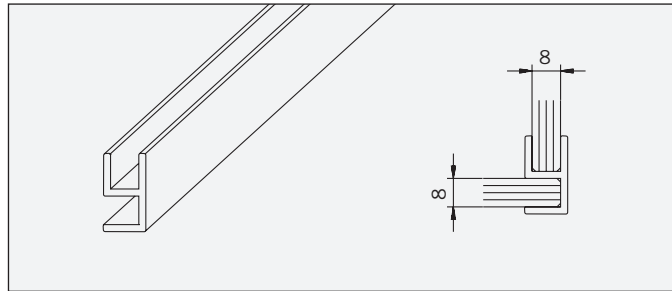

Art.-No. 04.5220

Corner connection profil 90°, transparent acrylic, for 8 mm glass.

Weight: 0,130 kg/m

Art.-Nr. 04.5230

Glasschutz 11 mm, PVC weich. Schützt das Glas beim Einsetzen in Metallprofile.

Gewicht: 0,036 kg/m

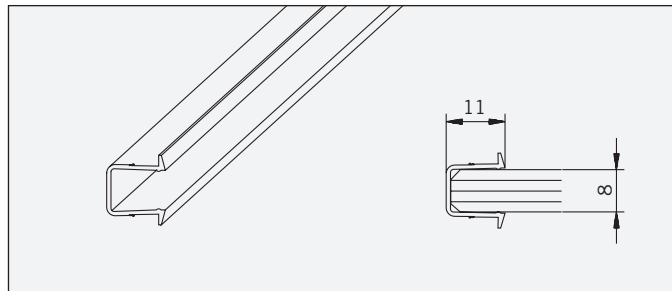

Art.-No. 04.5230

Glass protection 11 mm, PVC soft. Protects the glass during insertion into the metal profiles.

Weight: 0,036 kg/m

Art.-Nr. 04.5240

Glasschutz 17,5 mm, PVC weich. Schützt das Glas beim Einsetzen in Metallprofile.

Gewicht: 0,050 kg/m

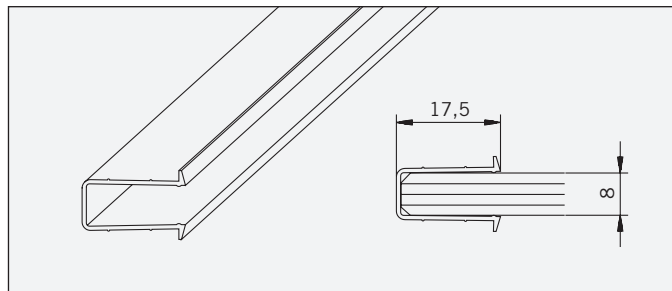

Art.-No. 04.5240

Glass protection 17.5 mm, PVC soft. Protects the glass during insertion into the metal profiles.

Weight: 0,050 kg/m

Art.-Nr. 04.5250

Magnetdichtung 135°, als 180°-Verbindung, Acryl transparent, Lieferung paarweise. Für 6-8 mm Glas.

Art.-Nr. 04.5396

Für 8-10 mm Glas.

Gewicht: 0,102 kg/m

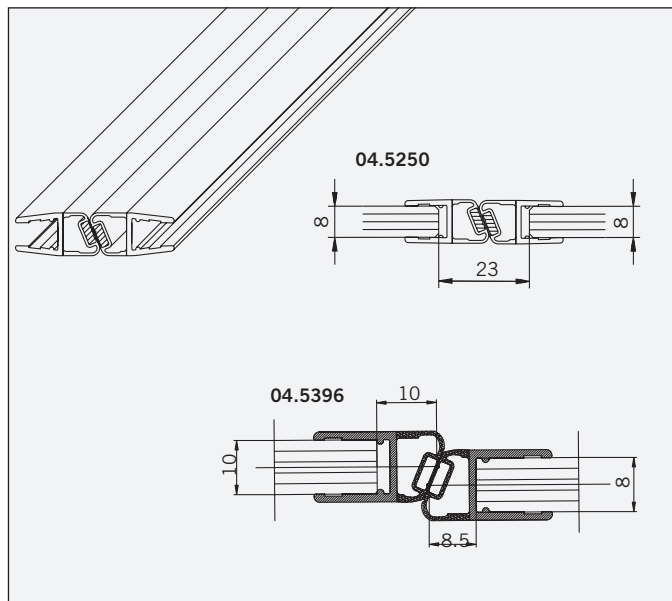

Art.-No. 04.5250

Magnetic seal 135°, for 180° connection, transparent acrylic, supplied in pairs. For 6-8 mm glass.

Art.-No. 04.5396

For 8-10 mm glass.

Weight: 0,102 kg/m

Art.-Nr. 04.5270

Magnetdichtung 135°, als 135°-Verbindung, Acryl transparent, Lieferung paarweise. Für 6-8 mm Glas, L: 2000 mm

Art.-Nr. 04.5271

Für 6-8 mm Glas, L: 2500 mm

Art.-Nr. 04.5390

Für 8-10 mm Glas, L: 2000 mm

Gewicht: 0,102 kg/m

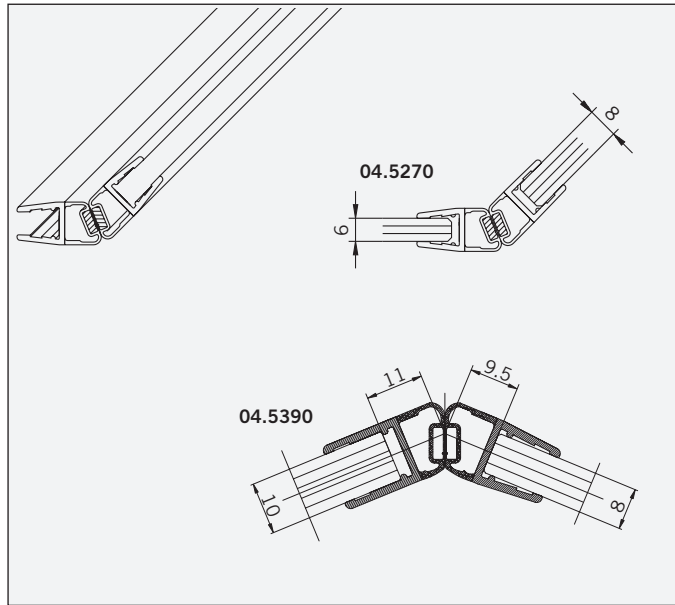

Art.-No. 04.5270

Magnetic seal 135°, for 135° connection, transparent acrylic, supplied in pairs. For 6-8 mm glass, L: 2000 mm

Art.-No. 04.5271

For 6-8 mm glass, L: 2500 mm

Art.-No. 04.5390

For 8-10 mm glass, L: 2000 mm

Weight: 0,102 kg/m

Art.-Nr. 04.5290

Magnetdichtung 90°, Acryl transparent, Lieferung paarweise. Für 6-8 mm Glas, L: 2000 mm

Art.-Nr. 04.5380

Für 8-10 mm Glas, L: 2000 mm

Art.-Nr. 04.5291

Für 6-8 mm Glas, L: 2500 mm

Gewicht: 0,102 kg/m

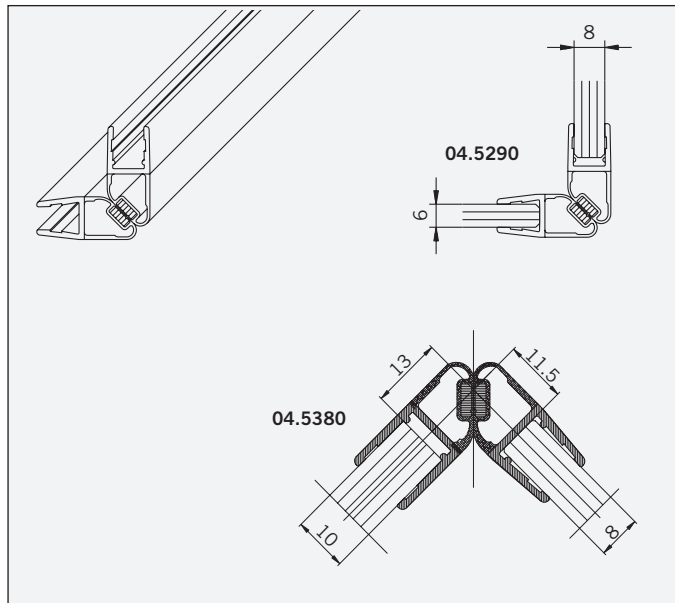

Art.-No. 04.5290

Magnetic seal 90°, transparent acrylic, supplied in pairs. For 6-8 mm glass, L: 2000 mm

Art.-No. 04.5380

For 8-10 mm glass, L: 2000 mm

Art.-No. 04.5291

For 6-8 mm glass, L: 2500 mm

Weight: 0,102 kg/m

Art.-Nr. 04.5310

Universalmagnetdichtung, für 90° bis 180°-Verbindungen, Lieferung paarweise, für 6-8 mm Glas. L: 2000 mm

Art.-Nr. 04.5312

L: 2500 mm

Gewicht: 0,320 kg/m

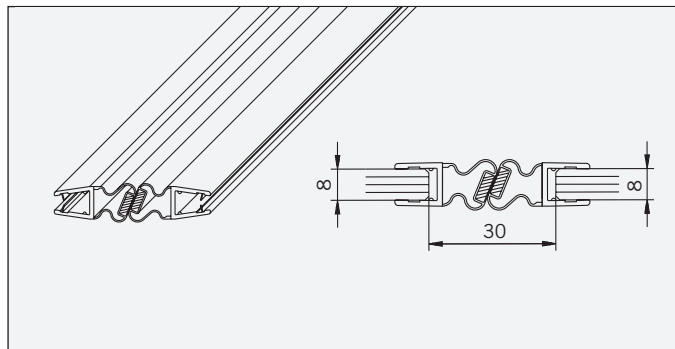

Art.-No. 04.5310

Universal magnetic seal, for 90° to 180° connection, supplied in pairs, for 6-8 mm glass, L: 2000 mm

Art.-No. 04.5312

L: 2500 mm

Weight: 0,320 kg/m

Art.-Nr. 04.5350

H-Profil, groß, Acryl transparent,
für 8 mm Glas,
L: 2000 mm

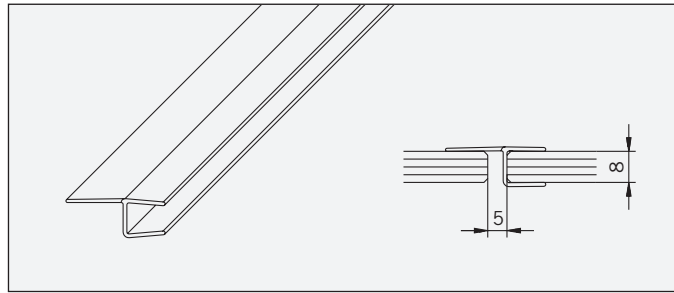

Art.-No. 04.5350

H-profile, large, transparent acrylic,
for 8 mm glass,
L: 2000 mm

Art.-Nr. 04.5351

L: 2500 mm

Art.-No. 04.5351

L: 2500 mm

Gewicht: 0,071 kg/m

Weight: 0,071 kg/m

Art.-Nr. 04.5360

Magnetdichtung 180°,
Acryl transparent,
Lieferung paarweise.
Für 6-8 mm Glas,
L: 2000 mm

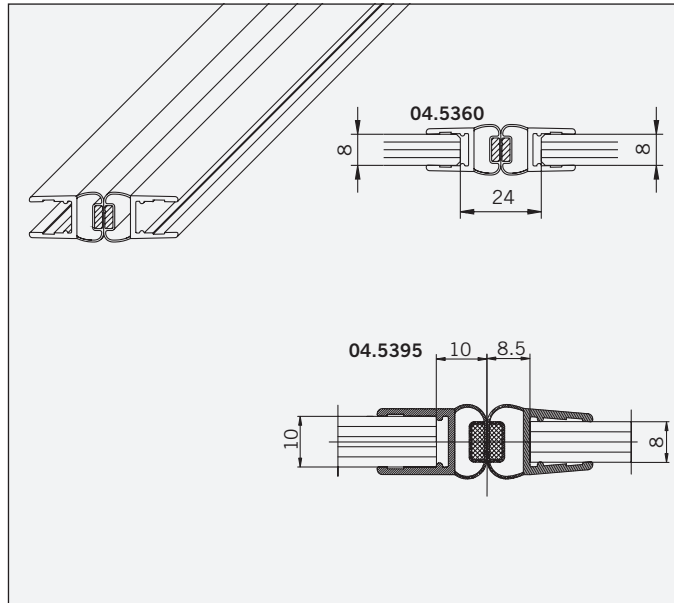

Art.-No. 04.5360

Magnetic seal 180°, transparent
acrylic,
supplied in pairs.
For 6-8 mm glass,
L: 2000 mm

Art.-Nr. 04.5395

Für 8-10 mm Glas,
L: 2000 mm

Art.-No. 04.5395

For 8-10 mm glass,
L: 2000 mm

Art.-Nr. 04.5361

Für 6-8 mm Glas,
L: 2500 mm

Art.-No. 04.5361

For 6-8 mm glass,
L: 2500 mm

Gewicht: 0,086 kg/m

Weight: 0,086 kg/m

Art.-Nr. 04.5410

Mitteldichtung, rund,
Acryl transparent,
für 8mm Glas,
L: 2000 mm

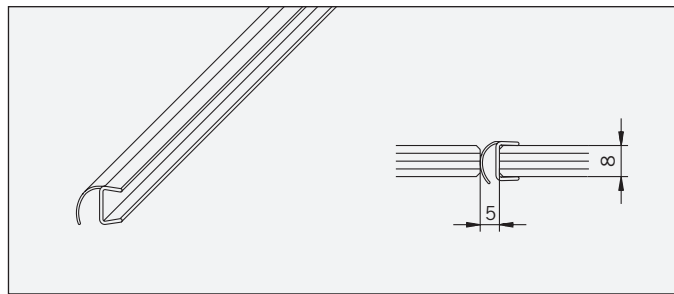

Art.-No. 04.5410

Middle seal, round,
transparent acrylic,
for 8mm glass,
L: 2000 mm

Art.-Nr. 04.5411

L: 2500 mm

Art.-No. 04.5411

L: 2500 mm

Gewicht: 0,067 kg/m

Weight: 0,067 kg/m

Art. Nr. 04.5413

Mitteldichtung, rund, Acryl
transparent nur für 10 mm Glas.

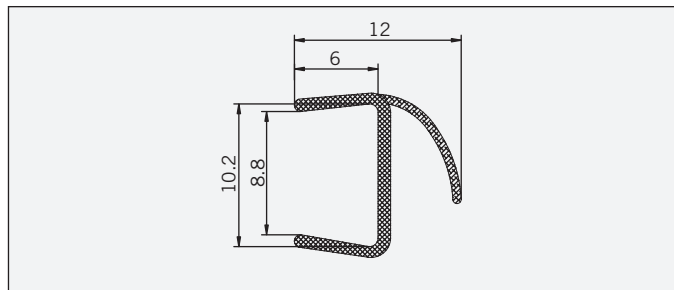

Art.-No. 04.5413

Middle seal, round, transparent
acrylic only for
10 mm glass

Gewicht: 0,07 kg/m

Weight: 0,07kg/m

Art.-Nr. 04.5500

Dichtprofil, Acryl transparent.
Zur zusätzlichen Abdichtung bei
ungünstigen Wannensituationen.

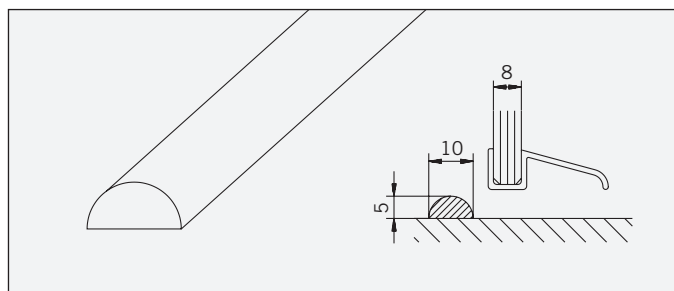

Art.-No. 04.5500

Sealing profile, transparent
acrylic. For additional sealing
in case bathtub is placed
unfavorably.

Gewicht: 0,130 kg/m

Weight: 0,130 kg/m

Art.-Nr. 04.5510

Dichtprofil, Acryl transparent, zur zusätzlichen Abdichtung bei ungünstiger Wannensituation.
L: 2000 mm

Gewicht: 0,200 kg/m



Art.-No. 04.5510

Sealing profile, transparent acrylic, for additional sealing in case bathtub is placed unfavorably.
L: 2000 mm

Weight: 0,200 kg/m

Art.-Nr. 04.5600

Mitteldichtung 135°, Acryl transparent, für 6 mm Glas, für Fünfeckkabinen.
L: 2000 mm

Art.-Nr. 04.5601

L: 2500 mm

Gewicht: 0,057 kg/m

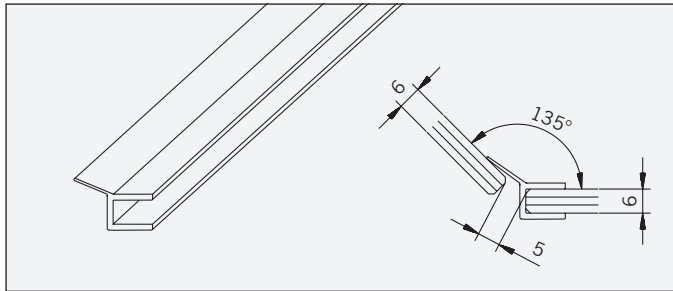

Art.-No. 04.5600

Middle seal 135°, transparent acrylic, for 6 mm glass, for pentagonal showers.
L: 2000 mm

Art.-No. 04.5601

L: 2500 mm

Weight: 0,057 kg/m

Art.-Nr. 04.5850

H-Profil, klein, Acryl transparent, für 8 mm Glas.
L: 2000 mm

Art.-Nr. 04.5851

L: 2500 mm

Gewicht: 0,061 kg/m

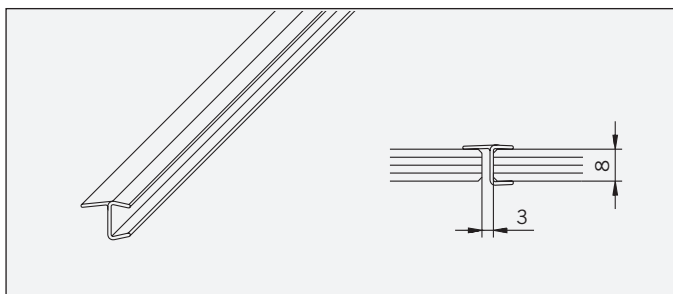

Art.-No. 04.5850

H-profile, small, transparent acrylic, for 8 mm glass.
L: 2000 mm

Art.-No. 04.5851

L: 2500 mm

Weight: 0,061 kg/m

Art.-Nr. 04.5880

Lippendichtung, für 8 mm Glas.

Gewicht: 0,086 kg/m



Art.-No. 04.5880

Lip seal, for 8 mm glass.

Weight: 0,086 kg/m

Art.-Nr. 04.5890

Lippendichtung, für 8 mm Glas.

Gewicht: 0,093 kg/m

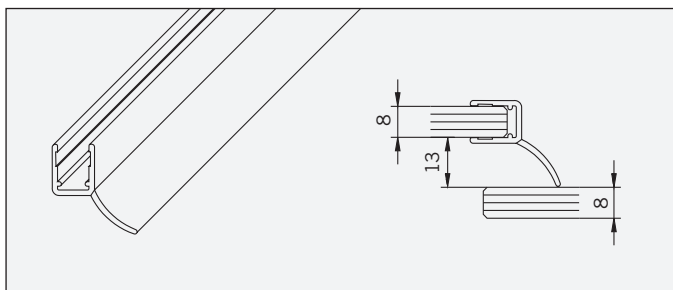

Art.-No. 04.5890

Lip seal, for 8 mm glass.

Weight: 0,093 kg/m

Art.-Nr. 04.5900

Schlauchdichtung, für 6 mm Glas.

Gewicht: 0,081 kg/m

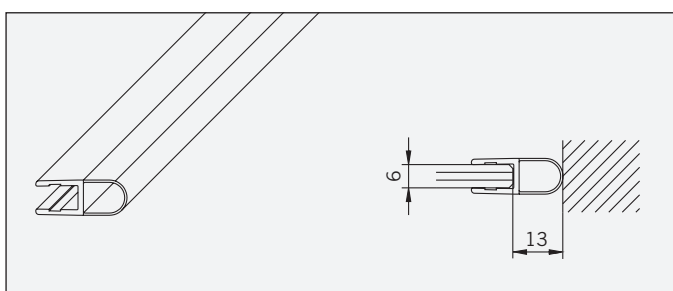

Art.-No. 04.5900

Soft nose seal, for 6 mm glass.

Weight: 0,081 kg/m

Art.-Nr. 04.5910
Schlauchdichtung,
für 8 mm Glas.
L: 2000 mm

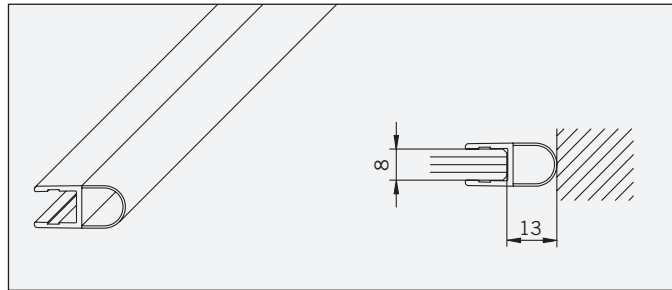

Art.-No. 04.5910
Soft nose seal,
for 8 mm glass.
L: 2000 mm

Art.-Nr. 04.5911
L: 2500 mm

Art.-No. 04.5911
L: 2500 mm

Gewicht: 0,085 kg/m

Weight: 0,085 kg/m

Art.-Nr. 04.5930
Schlauchdichtung,
für 8 mm Glas.



Art.-No. 04.5930
Soft nose seal,
for 8 mm glass.

Art. Nr. 04.5932
L: 2500 mm

Art.-No. 04.5932
L: 2500 mm

Gewicht: 0,076 kg/m

Weight: 0,076 kg/m

Art. Nr. 04.5931
Schlauchdichtung, Acryl trans-
parent für 8-10 mm Glas.
L: 2000 mm

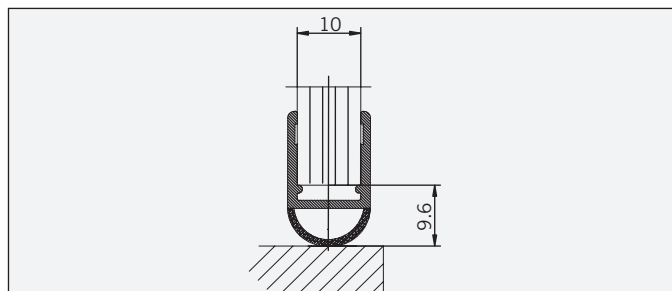

Art.-No. 04.5931
Soft nose seal, transparent acrylic
for 8-10 mm glass.
L: 2000 mm

Gewicht: 0,09 kg/m

Weight: 0,09 kg/m

Art.-Nr. 04.5940
Anschlagdichtung 90°,
für 8 mm Glas.

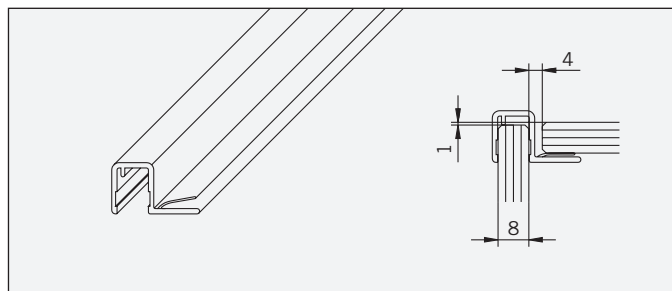

Art.-No. 04.5940
Rebate seal 90°,
for 8 mm glass.

Gewicht: 0,099 kg/m

Weight: 0,099 kg/m

Art.-Nr. 04.5950
Lippendichtung,
für 8 mm Glas.



Art.-No. 04.5950
Lip seal,
for 8 mm glass.

Gewicht: 0,127 kg/m

Weight: 0,127 kg/m

Art.-Nr. 04.5960
Lippendichtung,
für 8 mm Glas.

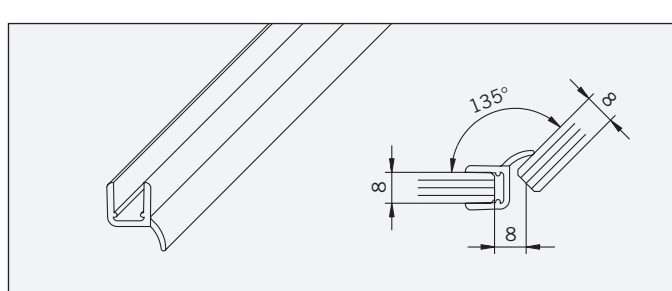

Art.-No. 04.5960
Lip seal,
for 8 mm glass.

Gewicht: 0,079 kg/m

Weight: 0,079 kg/m

Art. Nr. 04.5961

Lippendichtung, Acryl
transparent für
8-10 mm Glas.

Gewicht: 0,08 kg/m

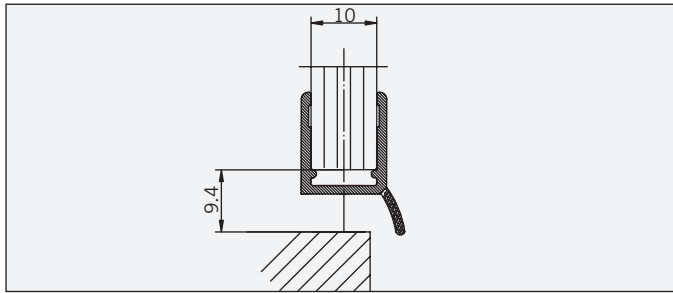

Art.-No. 04.5961

Lip seal, transparent acrylic
for 8-10 mm glass.

Weight: 0,08 kg/m

Art.-Nr. 04.5980

Dichtung mit langer Lippe,
für 6 mm Glas.

Gewicht: 0,095 kg/m

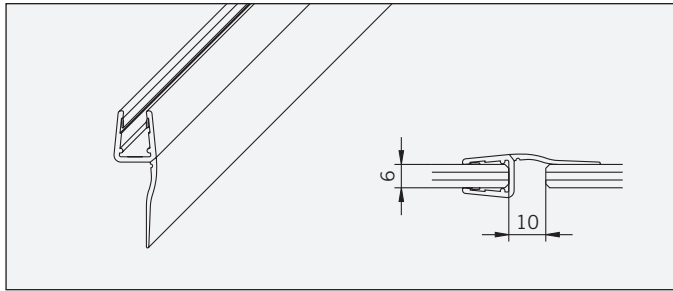

Art.-No. 04.5980

Seal with long lip,
for 6 mm glass.

Weight: 0,095 kg/m

Art.-Nr. 04.5990

Wasserabweiser mit weicher
Lippe, für 6 mm Glas.

Gewicht: 0,096 kg/m



Art.-No. 04.5990

Water disperser with soft lip,
for 6 mm glass.

Weight: 0,096 kg/m

Art.-Nr. 04.6000

Lippendichtung,
für 8 mm Glas.

Gewicht: 0,064 kg/m

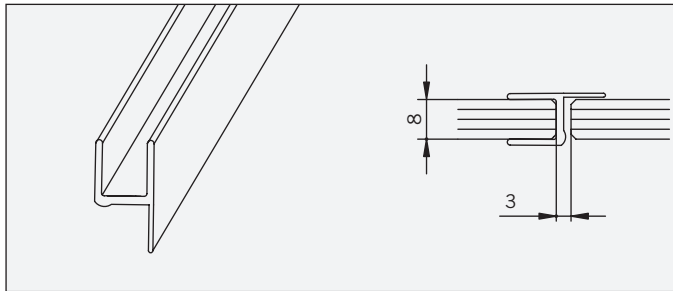

Art.-No. 04.6000

Lip seal,
for 8 mm glass.

Weight: 0,064 kg/m

Art.-Nr. 04.6010

Spaltdichtung,
für 8 mm Glas.

Gewicht: 0,087 kg/m

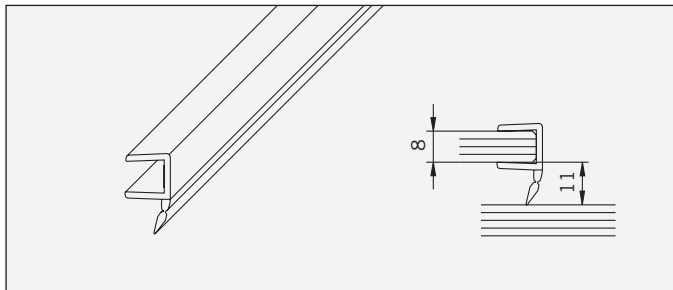

Art.-No. 04.6010

Gap seal,
for 8 mm glass.

Weight: 0,087 kg/m