

15.81030.01

Duschtürscharnier Classtec Bella

Material: brass
Finish: chrome polished
Mounting: glass/glass 90° or 180°
Glass thickness: 8 / 10 mm
Sales unit (SU): St
Unit package: 1.00
Shape: square
Glass processing: Glass drill hole : Ø18 mm
Carrying capacity: 40 kg/pair

verdeckte Verschraubungen, max. Türgröße 1000 x 2250 mm



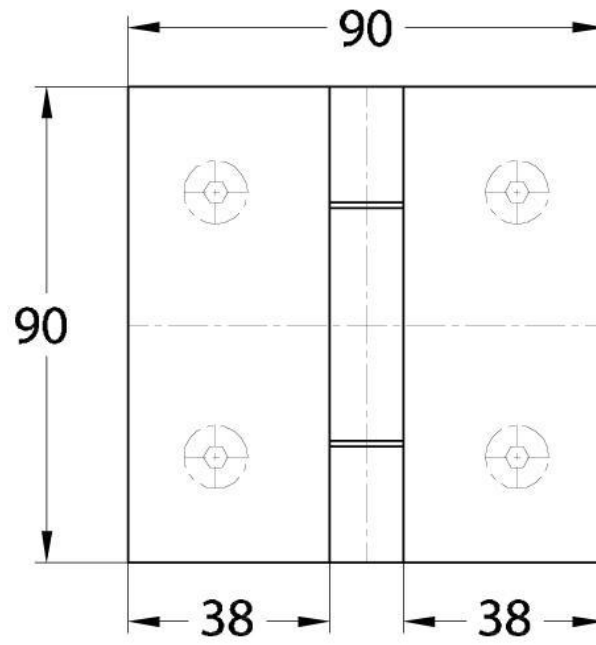
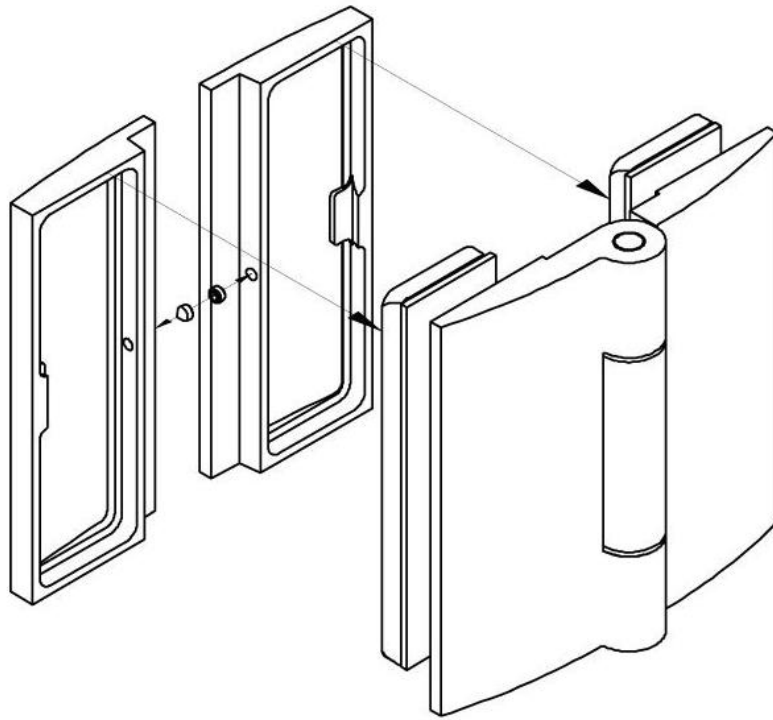

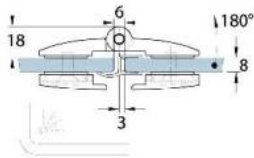

Mit Dichtprofil // with use of seal
(Art.-Nr. // art.no. 69090)

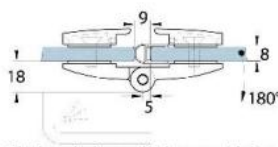
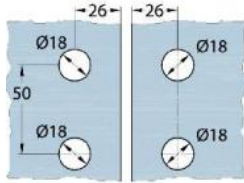

Glasbearbeitung // glass machining
Mit Dichtprofil Art.-Nr. 69030 o. 69230
with use of seal art. nr. 69030 or 69230

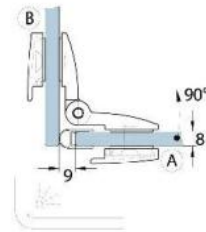
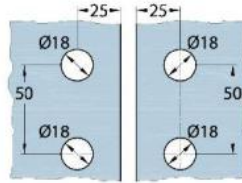

Mit Dichtprofil Art.-Nr. 69030 o. 69230
with use of seal art. nr. 69030 or 69230

