

15.81030.01

Charnière de douche Classtec Bella

Matériau:	laiton
Finition:	chromé poli
Montage:	verre/verre 90° ou 180°
Épaisseur du verre:	8 / 10 mm
Unité de vente (UV):	St
unité d'emballage (UE):	1.00
Forme:	carré
Travail du verre:	Perçage du verre : Ø18 mm
Capacité de charge:	40 kg/paire

vis cachées, dimensions de la porte max. 1000 x 2250 mm



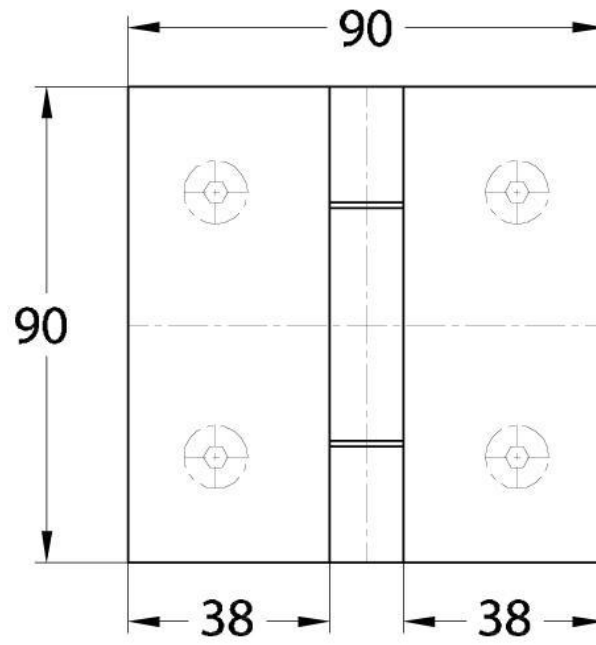
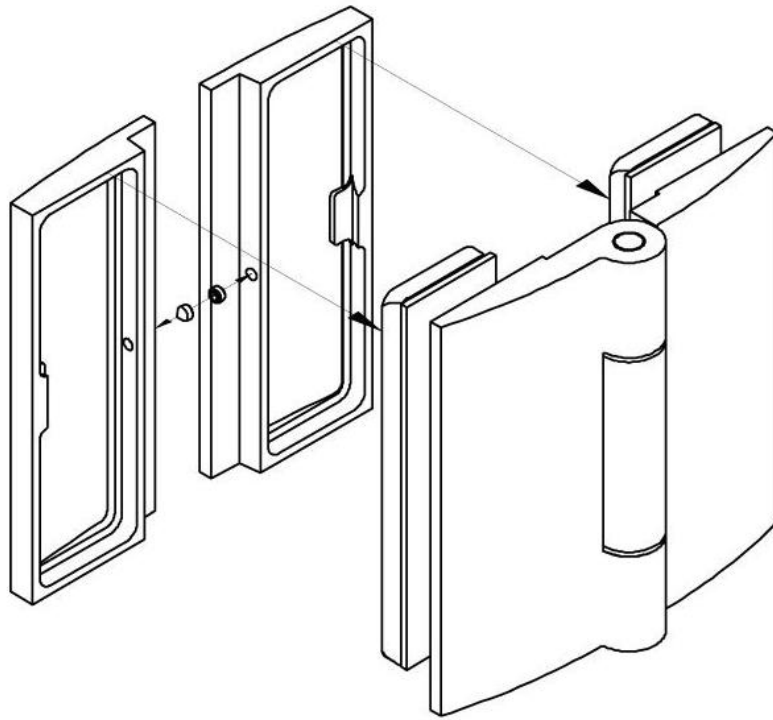

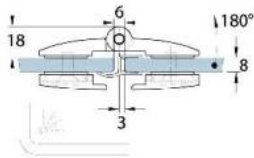

Mit Dichtprofil // with use of seal
(Art.-Nr. // art.no. 69090)

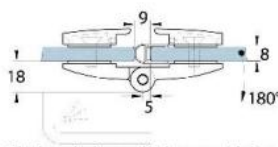
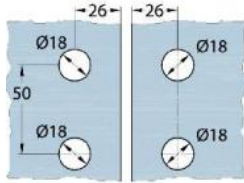

Glasbearbeitung // glass machining
Mit Dichtprofil Art.-Nr. 69030 o. 69230
with use of seal art. nr. 69030 or 69230

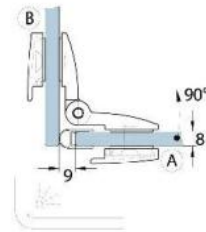
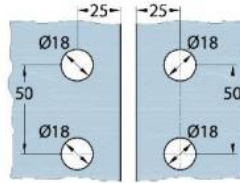

Mit Dichtprofil Art.-Nr. 69030 o. 69230
with use of seal art. nr. 69030 or 69230

