

31.87101.22

Fluido+ 110, Komplett-Set für 1 Schiebetür, einflügelig, 2 x Soft-Close

Material:	Aluminium
Ausführung:	naturfarbig eloxiert EV1
Montage:	Decken-/Wandmontage
Glasstärke:	10 - 12.76 mm
Verkaufseinheit (VE):	St
Packungseinheit (PE):	1.00
Stangenlänge (L):	3000 mm
Tragkraft:	110 kg/Garnitur

enthält: 1 x Laufschiene 3000 mm, 2 x Soft-Close, 2 x Rollwagen zum Klemmen, 1 x Bodenführung, Türbreite mind. 920 mm, **seitliche Abdeckungen bitte separat bestellen**

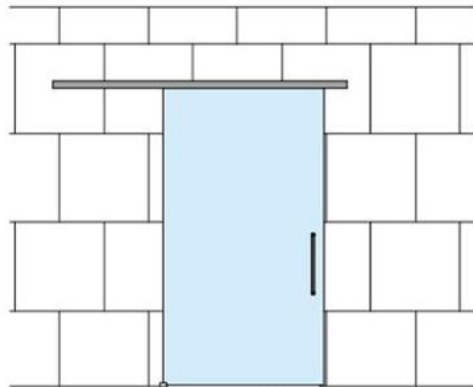
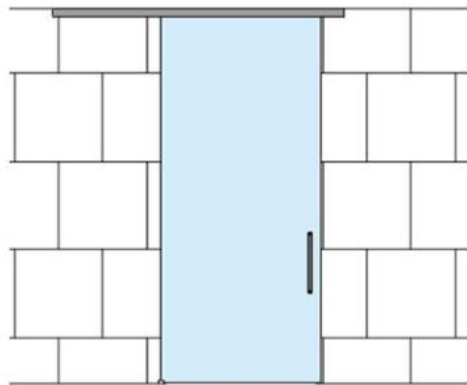

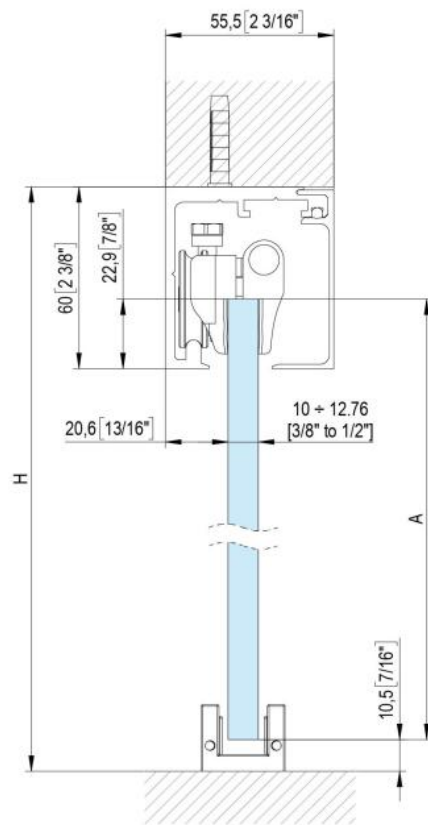
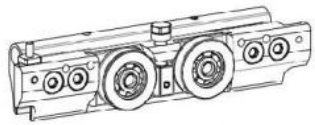
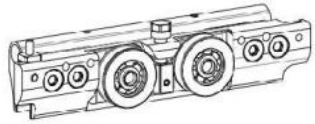
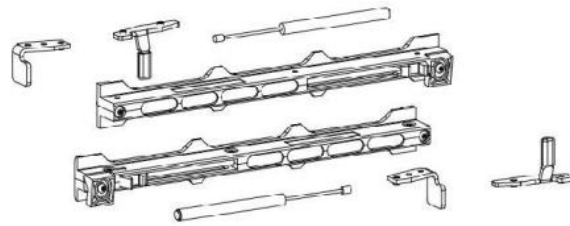
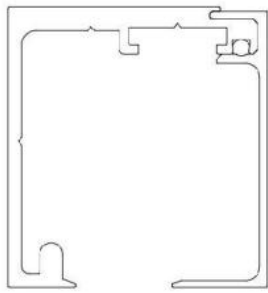

$$A = H - 48$$
$$[A = H - 1 \frac{7}{8}"]$$

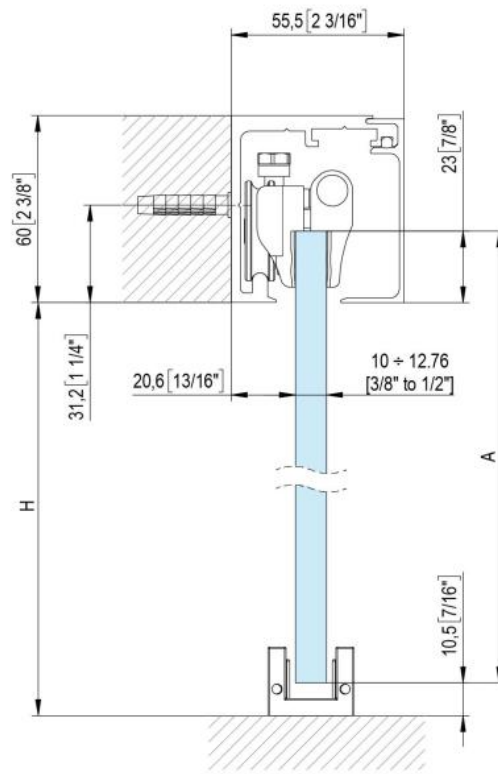

$$A = H + 12$$

$$[A = H + 1/2"]$$