

## 15.81030.01

### Duschtürscharnier Classtec Bella

Material:	Messing
Ausführung:	verchromt poliert
Montage:	Glas/Glas 90° oder 180°
Glasstärke:	8 / 10 mm
Verkaufseinheit (VE):	St
Packungseinheit (PE):	1.00
Form:	eckig
Glasbearbeitung:	Glasbohrung : Ø18 mm
Tragkraft:	40 kg/Paar

verdeckte Verschraubungen, max. Türgröße 1000 x 2250 mm



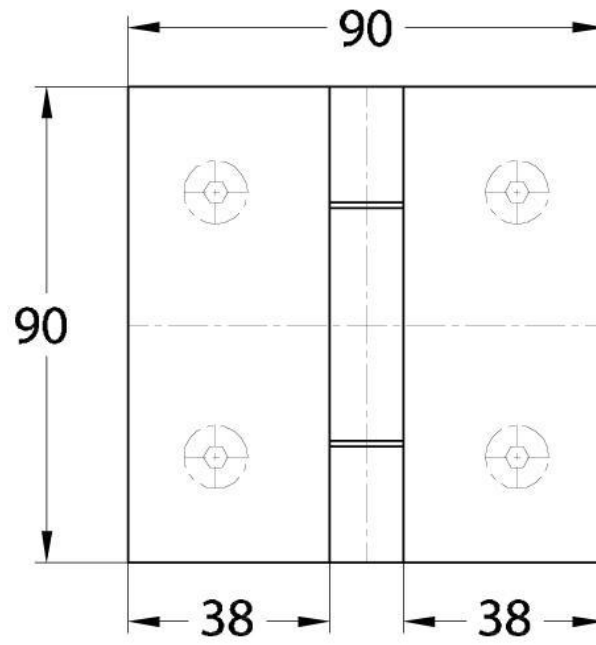
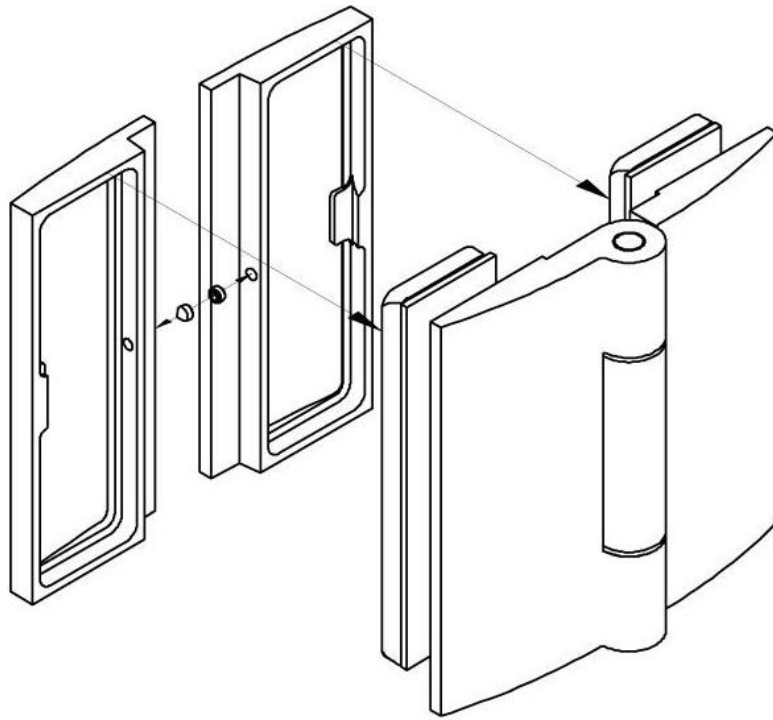

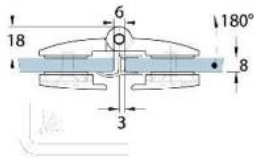

Mit Dichtprofil // with use of seal  
(Art.-Nr. // art.no. 69090)

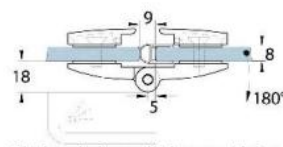
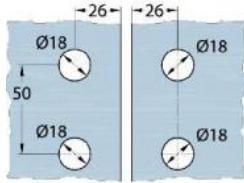

Glasbearbeitung // glass machining

Mit Dichtprofil Art.-Nr. 69030 o. 69230  
with use of seal art. nr. 69030 or 69230

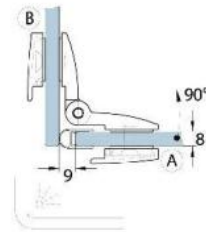
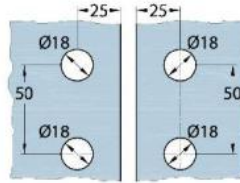

Mit Dichtprofil Art.-Nr. 69030 o. 69230  
with use of seal art. nr. 69030 or 69230

