

31.70006.21

Duschtürsystem BX-4000 LINEA 30, Komplett-Set für Nischendusche, einflügelig

Material:	Aluminium
Ausführung:	Chromeffekt
Montage:	Glas/Wand
Glasstärke:	8 mm
Verkaufseinheit (VE):	St
Packungseinheit (PE):	1.00
Form:	eckig
Stangenlänge (L):	3000 mm
Glasbearbeitung:	Glasausschnitt
Tragkraft:	32 kg/Garnitur

enthält: 1 x Laufschiene mit Sichtschutzprofil, 2 x Laufrollen, 1 x Wandhalter rechts, 1 x Wandhalter links, 1 x Stopper, 1 x Bodenprofil, 1 x Sichtschutzprofil, 1 x Bodenführung, Türbreite min. 550 mm / max. 750 mm. Duschtürknöpfe bitte separat bestellen

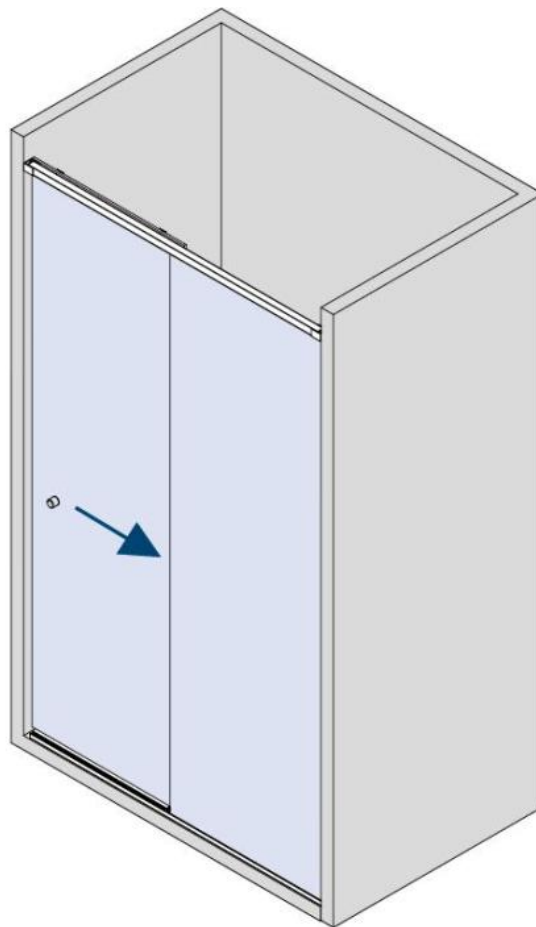



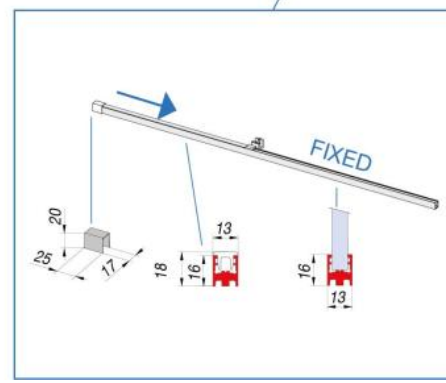
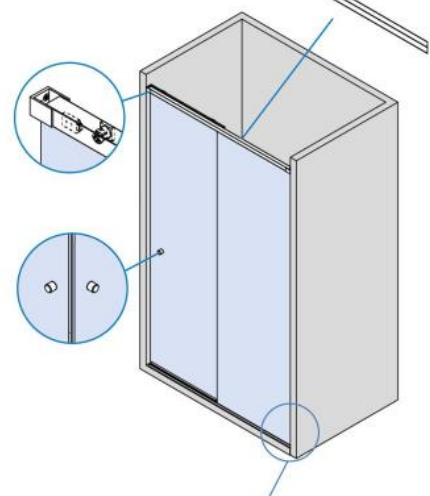
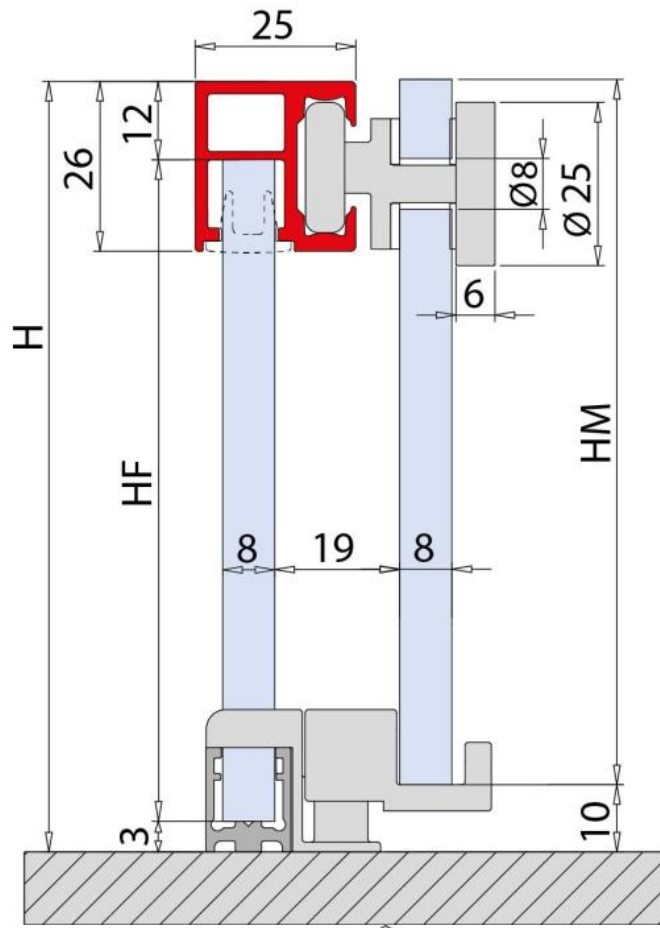

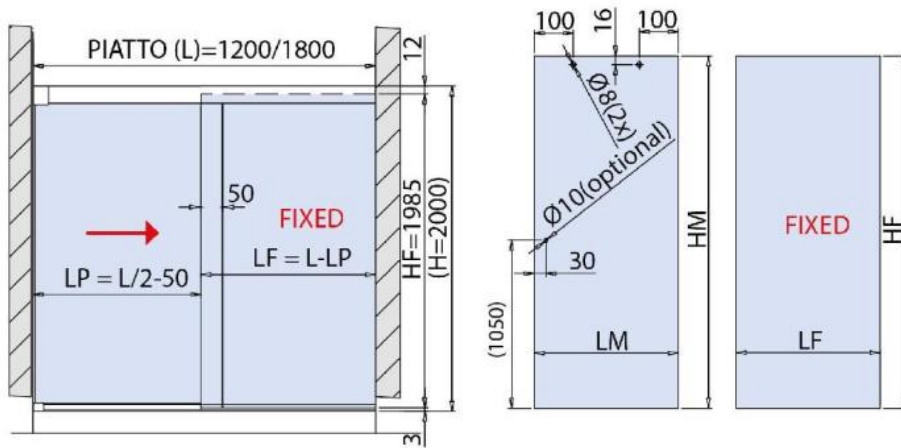

GLASBERECHNUNG / CALCULATION VERRE / CALCOLO VETRO

$L = 1200 - 1800$ mm

$LP = L / 2 - 50$

$LM = LP + 45$

$LF = L - LP$ - (Spaltmass / espace entre verre et mur / aria variabile)

$HM = H - 10 = 1990$ mm

$HF = H - 15 = 1985$ mm

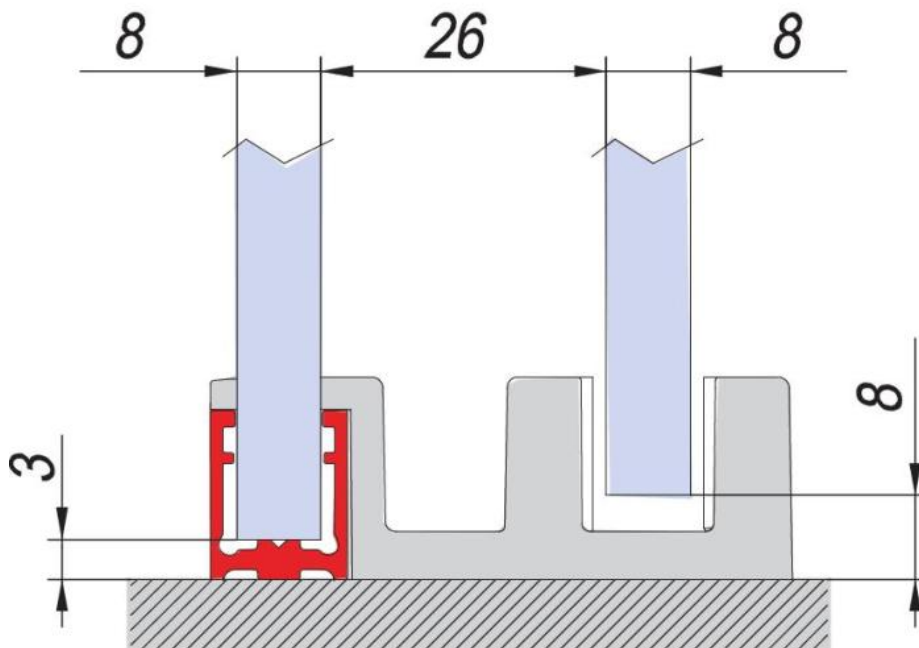

$$HM = H - 8$$

$$HF = H - 3$$