

61.62240.02

Winkelverbinder

Material:	Messing
Ausführung:	matt velour
Montage:	Glas/Glas 90°
Glasstärke:	8 / 10 mm
Verkaufseinheit (VE):	St
Packungseinheit (PE):	1.00
Form:	abgerundete Ecken
Masse:	40 x 50 mm
Glasbearbeitung:	Glasbohrung : Ø14 mm

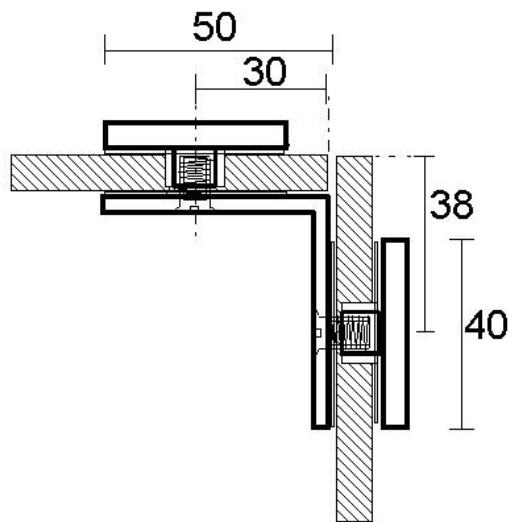



$\text{Ø}14$

