

57.79420.16

Bâton de maréchal

Matériau:	inox V2A
Finition:	brossé
Montage:	montage verre (paire)
Épaisseur du verre:	8 - 12 mm
Unité de vente (UV):	Pr
unité d'emballage (UE):	1.00
Forme:	rond
Mesures:	Ø 20 mm, L = 420 mm
Mesure A:	420 mm
Mesure B:	400 mm
Mesure C:	50 mm
Mesure D:	20 mm
Travail du verre:	Perçage du verre : Ø14 mm
Filetage:	M10

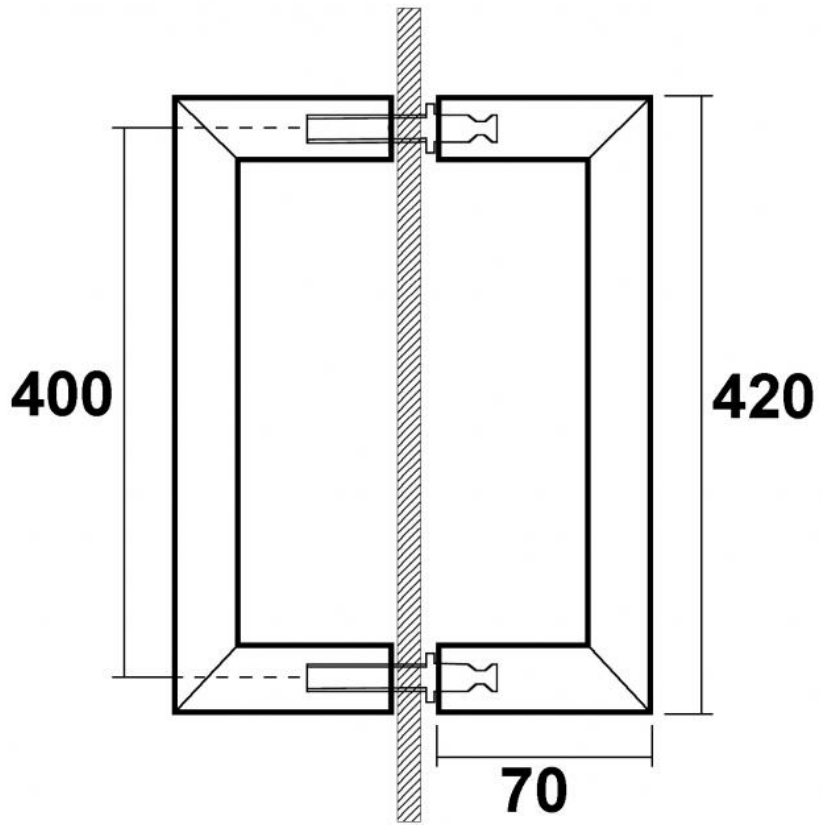



$\text{Ø}14$

