

61.62220.02

Winkelverbinder

Material: Messing
Ausführung: matt velour
Montage: Glas/Glas 90°
Glasstärke: 8 / 10 mm
Verkaufseinheit (VE): St
Packungseinheit (PE): 1.00
Form: rund
Masse: 40 x 50 mm
Glasbearbeitung: Glasbohrung : Ø14 mm

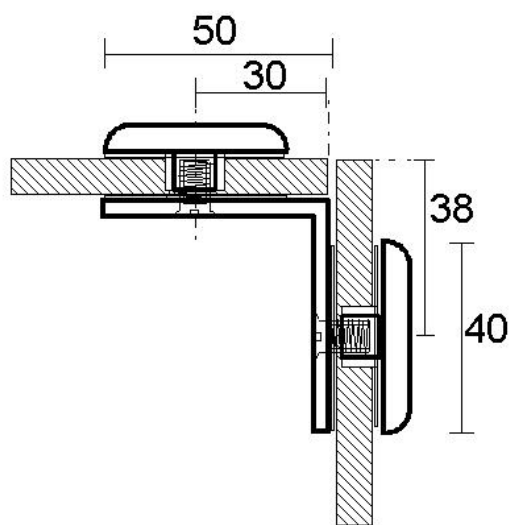



$\text{Ø}14$

