

61.62220.03

Equerre

Matériau: laiton
Finition: doré poli
Montage: verre/verre 90°
Épaisseur du verre: 8 / 10 mm
Unité de vente (UV): St
unité d'emballage (UE): 1.00
Forme: rond
Mesures: 40 x 50 mm
Travail du verre: Perçage du verre : Ø14 mm

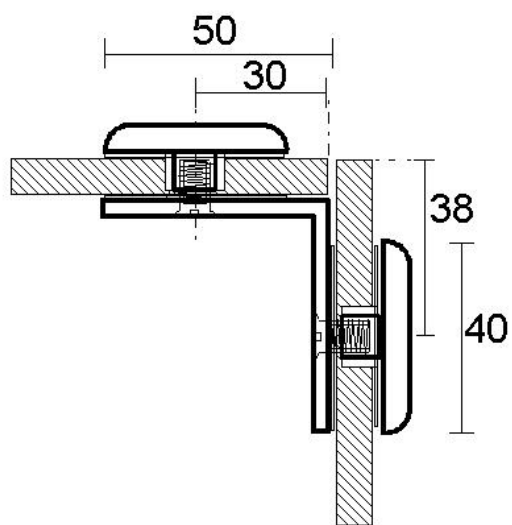



$\text{Ø}14$

